

Voice Lift with the BMA 360

What is the BMA 360?

The patented BMA 360 is the world's most technologically advanced ceiling tile beamforming microphone array. It's the world's first truly wideband, frequency invariant beamforming mic array. FiBeam technology gives users the ultimate in natural and full fidelity audio across all beams and within a single beam. The BMA 360's deep sidelobe beamforming, DsBeam™, provides unparalleled sidelobe depth, below -40 dB, resulting in superior rejection of reverb and noise, even in difficult spaces, for superb clarity and intelligibility.

What is Voice Lift?

The **purpose of Voice Lift is to Lift the audio heard by listeners at the farthest distance, to the level of an un-aided listener sitting closer to the talker.** Voice Lift provides a powerful and simple way to drive multiple mix-minus speaker zones allowing everyone in the room to hear every word.

Will Voice Lift work in my room design?

With the BMA 360 Voice Lift, ClearOne provides a tool to compute Potential Acoustic Gain (PAG), Needed Acoustic Gain (NAG), and the resultant lifted gain from the BMA 360 Voice Lift. A PAG/NAG calculator allows users to enter distances between Talker, Listeners, the BMA 360, and Loudspeaker(s), and learn if the teleconference room setup is sufficient for their needs or how the room elements may need to be adjusted.

PAG/NAG computations are easy, and the setup is easy too. The diagram shows the relationship between the following variables used by the PAG/NAG calculator:

D0 = Distance between the Talker and the Farthest Listener (the back Listener needs Voice Lift).

EAD = Equivalent Acoustic Distance = Distance between the Talker and Un-aided Listener
(Audio at farthest listener is lifted to the level of audio at the Un-aided Listener)

Ds = Distance between the Talker and the BMA 360.

D1 = Distance between the BMA 360 and the closest Loudspeaker.

D2 = Distance between Listener that needs Voice Lift and the closest Loudspeaker.

Related Documents

- [BMA 360 Datasheet](#)
- [BMA 360 Voice Lift Presentation](#)
- [BMA 360 DARE™ Configuration Guide](#)
- [CONSOLE® AI User Manual](#)

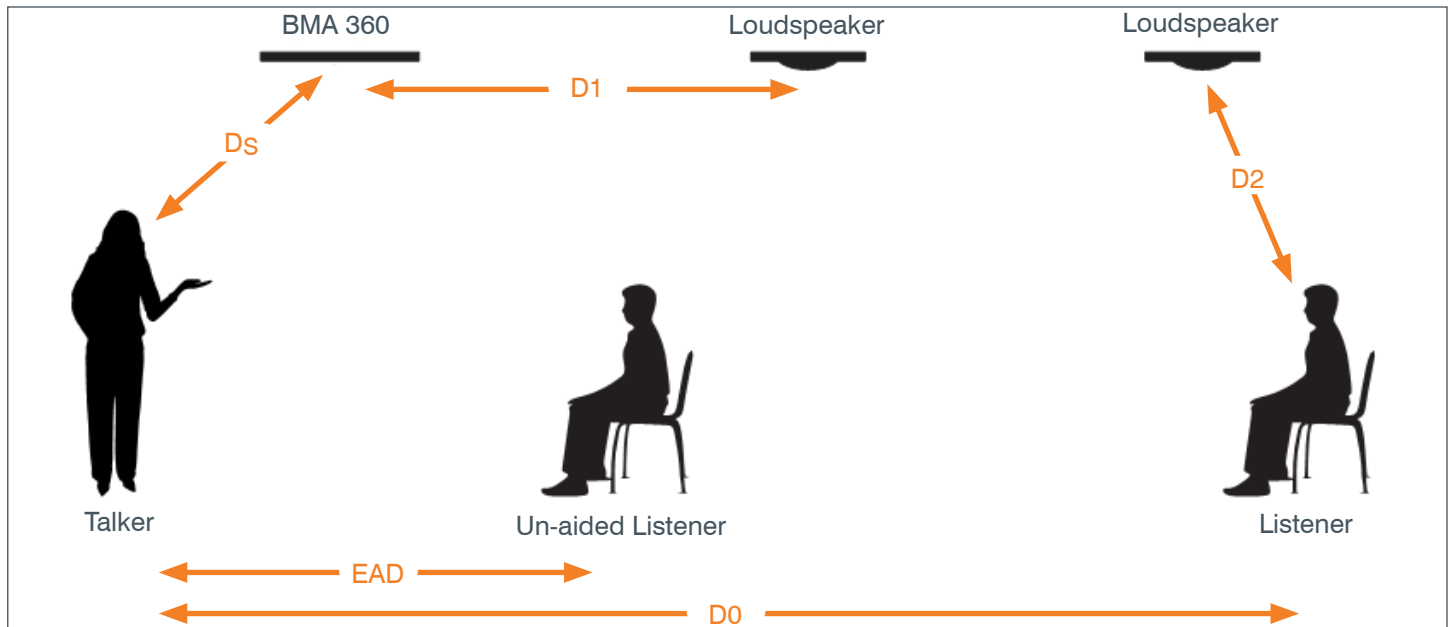

It's easy to see the purpose of Voice Lift is to Lift audio heard by listener at distance D0, to the equivalent level heard by the un-aided listener at EAD.

Thus, the "Needed Acoustic Gain" (NAG) is the amount of gain required to overcome the attenuation difference from the farthest Listener to the Un-aided Listener. Intuitively, this is expressed as the attenuation over distance D0 minus the attenuation over the distance EAD, or $D0 - EAD$ in dB.

In other words,

$$NAG = 20 \log (D0) - 20 \log (EAD) = 20 \log (D0/EAD).$$

Feedback Stability Margin (FSM) in dB can be added to the Needed Acoustic Gain for margin, and is 6 dB

$$NAG = 20 \log (D0/EAD) + FSM$$

Now if there are a 'number of open microphones' (NOM) , the typical NAG equation accounts for that:

$$NAG = 20 \log (D0/EAD) + 10 \log (NOM) + FSM$$

Note: For a BMA 360, $NOM = 1$ and is the number of beams = 1. Typically, the value = 1.

The next step is the Potential Acoustic Gain. When the Potential Acoustic Gain is equal to the Needed Acoustic Gain, there is *sufficient* Acoustic Gain to overcome the NAG inclusive of the Feedback Stability Margin or $PAG - NAG = 0$. PAG may be thought of similarly to NAG: in terms of potential attenuation to overcome the distances or

$$PAG = D0 + D1 - Ds - D2 \text{ in dB} = 20 \log \{D0 D1/(Ds D2) \}$$

For sufficient Gain without voice lift

$$PAG - NAG = 0$$

$$20 \log \{D0 D1/(Ds D2) \} - 20 \log (D0/EAD) - 10 \log (NOM) - FSM = 0$$

This is a baseline comparison and is labeled OMNI or

$$\text{OMNI} = \text{PAG} - \text{NAG}$$

Using a BMA 360 *significantly increases the gain over the baseline*. This is due to its beamforming directionality, controlled beamwidths, deep sidelobes, and frequency invariant gain pattern. The BMA boost is at least 12 dB conservatively, or

$$\text{BMA 360} = \text{OMNI} + \text{BMA Boost}$$

A BMA 360 number ≥ 0 means a successful setup. If it's < 0 , then the room configuration should be adjusted to yield a result ≥ 0 .

Note: A number greater than zero does not guarantee performance as other room conditions may vary.

How do I add Voice Lift to my CONSOLE AI design?

Now that the physical room design and gain expectations have been established. It is time to consider the elements we have to work with when designing a configuration file. With the release of BMA 360 firmware v1.0.4.x, CONVERGE® Pro 2 firmware v8.2.x.x and CONSOLE AI software v7.3.x.x, a new channel type for the BMA 360 microphones is available.

These are called “VL” or “Voice Lift” channels and provide the ability to create a custom mix of a BMA 360’s individual beams with extremely low audio input to output latency. These can be found under the Resource Assignment panel within CONSOLE AI.

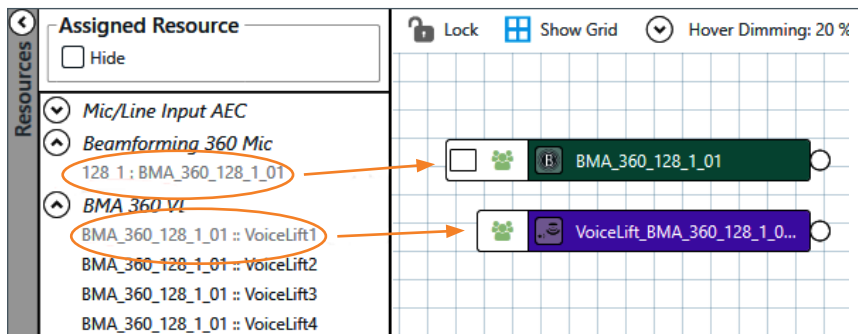

Opening a Voice Lift Channel view will provide the following control options:

- Pre-AEC mode: For local Voice Lift, always use Pre-AEC mode, as it provides minimal Latency and full spectrum sound.
- Post-AEC mode: For conferencing audio involving “far side” listeners use Post-AEC mode, which has higher latency but includes echo and noise cancellation.
- Gating controls: Gating is used to limit number of simultaneous open channels providing additional feedback control and talker prioritization options. This is discussed further below.
- Mute: Used to disable the VL Channel.
- Gain: Used to increase or decrease VL channel levels overall.

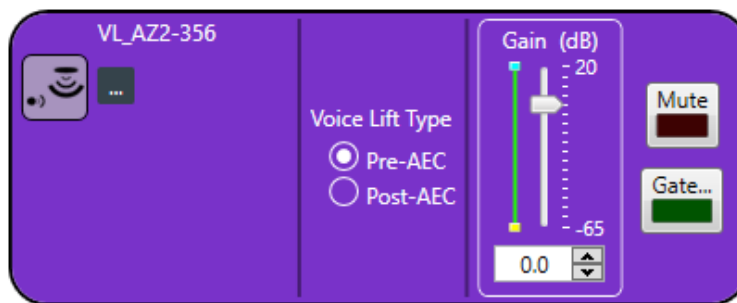

Opening the Advanced options dialogue  provides access to the Beam mixing selection, custom per-Beam level controls and the general BMA 360 properties and Configuration tabs as well.

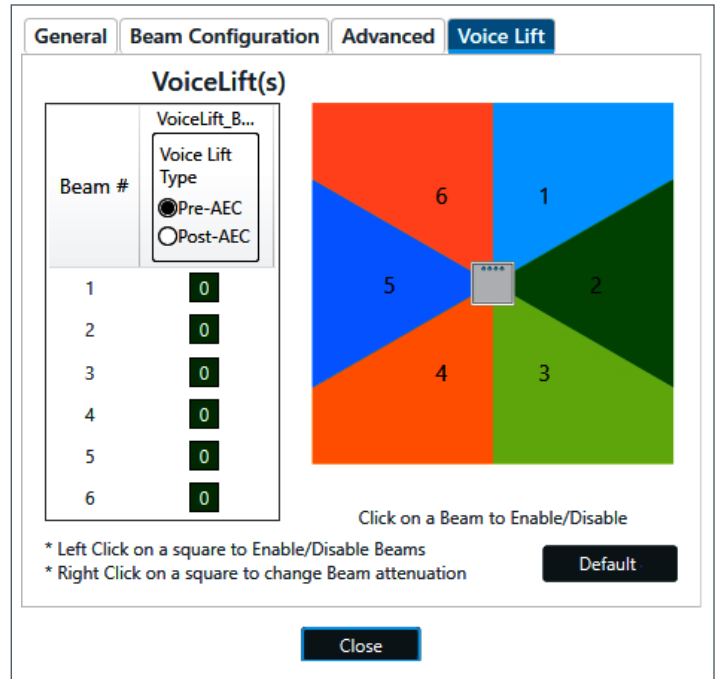

Voice Lift capabilities on the BMA 360 are further enhanced when paired with the DARE™ Feedback Eliminator that is found on all CONVERGE Pro 2 DSP Mixers. Further details on these powerful tools are provided below.

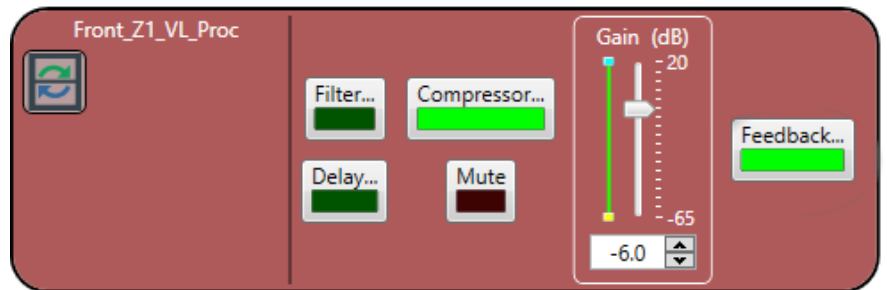

Putting it all together

Now that we have the rooms' PAG and NAG calculations and understand the basic programming elements. We are ready to design a file.

The first item to consider is the Beam Patterns to utilize in the space. The BMA 360 is capable of three general "Shapes" for pick-up that can then be further configured to account for the rooms size and seating arrangement. The shapes available are:

Full Circle/Square

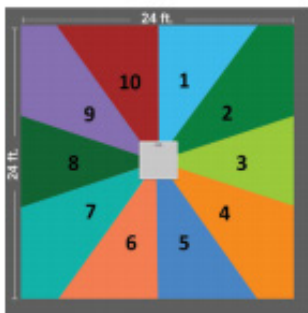

Rectangular



Semi-Circle/Classroom

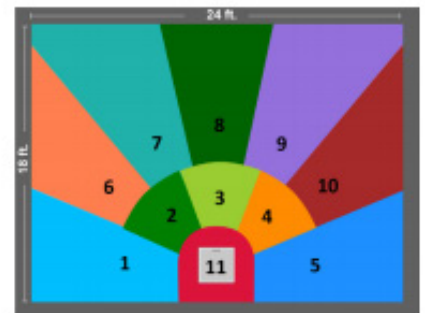

For example, consider the classroom diagram below. The BMA 360 is positioned directly over the instructor area and we wish to Voice Lift their speech to the Student areas. We also wish to pick up the Students' audio for transmission.

We have measured distances within this room and checked our PAG/NAG calculations to be sure we can provide sufficient Voice Lift gain.

ClearOne PAG-NAG Calculator

Variable (Hover for description)	Values (Edit Yellow Fields)	Units
D0	32	Ft or M
EAD	12	Ft or M
Ds	8	Ft or M
D1	6	Ft or M
D2	5	Ft or M
FSM	6	dB
NOM	1	count
PAG	13.62	dB
NAG	14.52	dB
OMNI	-0.89	dB
BMA 360 Boost	12	dB
BMA 360	11.11	dB

BMA 360 Green = Go (Value >=0)

Disclaimer: Results vary depending on acoustics of your room. A 'Go' is not a guarantee that your system will provide satisfactory results.
Note: FSM and NOM cells are set at suggested default values; yet cells are editable

©2021 ClearOne

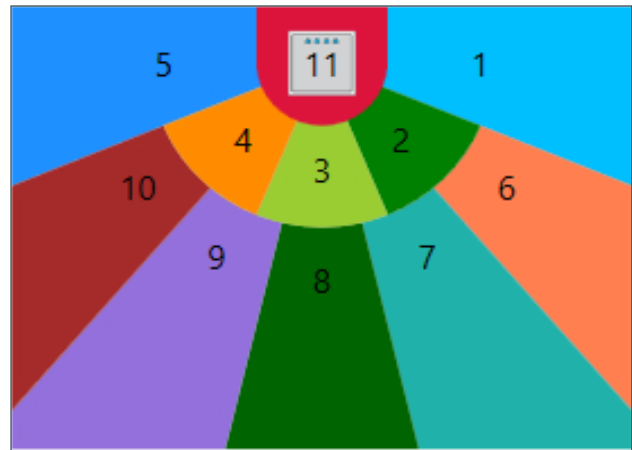
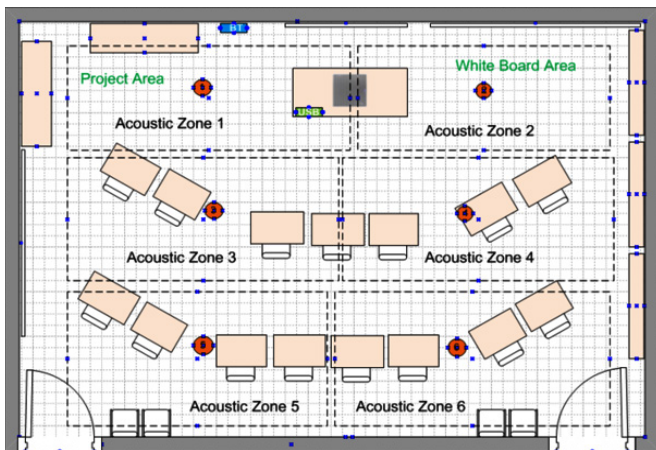

The ideal coverage shape in this case is Semi-Circular as it provides full coverage of the room while the BMA 360 is physically mounted off center. Here is another image of the classroom with this beam pattern overlaid.

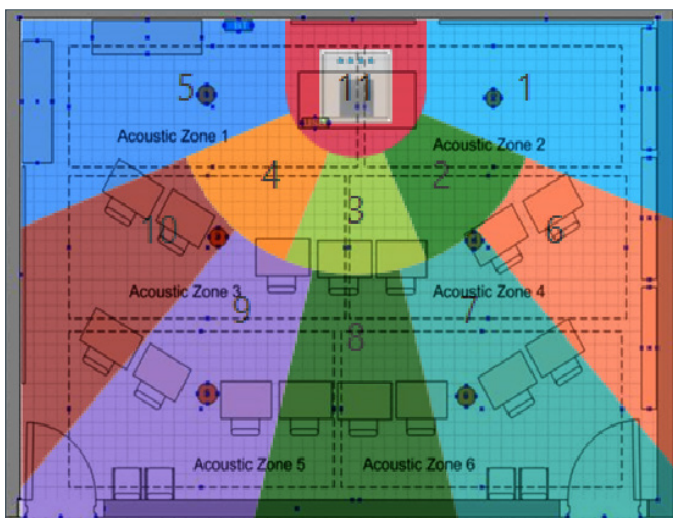

Note: Both BMA 360 Camera Tracking and Voice Lift features can be utilized simultaneously. However, they must use the same Beam Pattern selection.

Note the Acoustic Zone numbers in the diagram and how they relate to the overlay of Beam numbers. The instructor’s (top area) audio will be present in Beams 11, 5 and 1. Each of these Beams will benefit from having their own Voice Lift channel assigned.

This will allow each Beam to be individually adjusted and routed to Acoustic Zone speakers. This form of selective routing to maximize coverage distances is also called “Mix-Minus” routing.

We will send the instructor’s audio to areas over the Student seating areas Acoustic Zones 3, 4, 5 and 6, while Acoustic Zones 1 and 2 will only provide audio from far end participants.

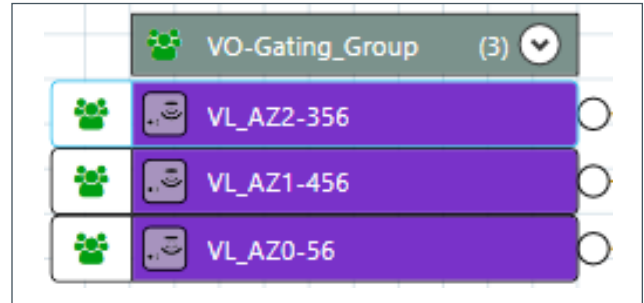

VoiceLift(s)			
Beam #	VL_AZ1-456	VL_AZ2-356	VL_AZ0-56
	Voice Lift Type ● Pre-AEC ○ Post-AEC	Voice Lift Type ● Pre-AEC ○ Post-AEC	Voice Lift Type ● Pre-AEC ○ Post-AEC
1		0	
2			
3			
4			
5	0		
6			
7			
8			
9			
10			
11			0

Click on a Beam to Enable/Disable

* Left Click on a square to Enable/Disable Beams
 * Right Click on a square to change Beam attenuation

Adding Processing blocks in line with these VL Channels will even further expand your control and tuning capabilities.

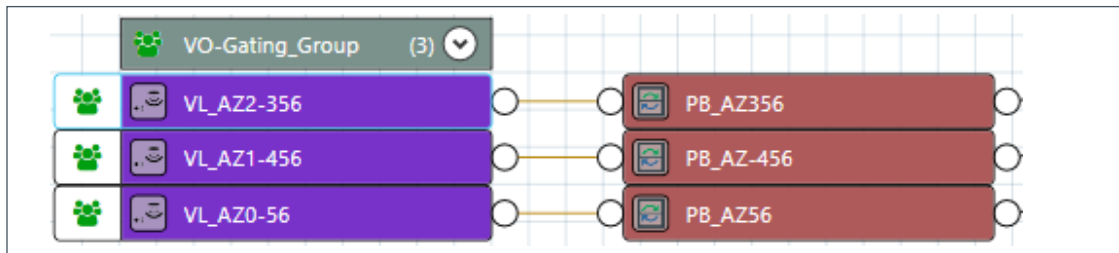

Opening a Processing Block Channel view will provide the following control options:

- Filter: A 15 Band suite of EQ options including Low Pass, High Pass, Notch, PEQ and many more.
- Delay: Fine tunable audio delay in .5 ms increments for 0 to 250 ms.
- Compressor: Compressor/Limiter with fully configurable attack, release and threshold controls.
- Mute: Disable audio pass-through.
- Gain: Provides adjustable levels Post-Compressor.
- Feedback: ClearOne’s 16 Band configurable DARE™ Feedback Eliminator. Provides both Automatic Max Gain Setup of Fixed filters, and the option to provide additional Dynamic filtering to remove detected feedback during system operation.

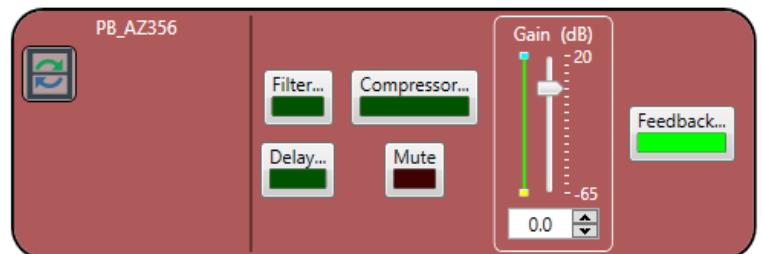

Feedback Eliminator - Front_Z1_VL_Proc

Enable Feedback Cancellation

Feedback Eliminator Settings

Filter Settings

Filter Bandwidth: Q = 5

Filter Depth Mode: Unlocked

Mode Settings

Mode: Voice

Enable Ringing Elimination

Automatic Setup

Run Setup State: Off

Number of Fixed Filters: 8

Target Gain Before Feedback: 8

Feedback Gain: 0.1 Total Nodes Used: 8

Affected Microphones

TrainingBP

TrainingHH

Affected Gating Groups

Tile-GG

Wireless-GG

GatingGroup03

Feedback Node Report

Type	Frequency	Q	Depth
Fixed	335.940	5.00	-12
Fixed	820.310	5.00	-6
Fixed	395.510	5.00	-3
Fixed	1468.750	5.00	-3
Fixed	570.310	5.00	-3
Fixed	3353.520	5.00	-3
Fixed	290.040	5.00	-3
Fixed	710.940	5.00	-3

Feedback Controls

Reset Feedback Eliminator Reset

Reset Dynamic Nodes Reset

Status

Fixed Node Count: 8

Dynamic Node Count: 0

Close

Continuing with the design. We can add a mixer block to route these VL Channels to the Students Acoustic Zones as planned. With CONSOLE AI, routing can be done in both FlowView and MatrixView. Choose the method that is most comfortable for you.

FlowView™

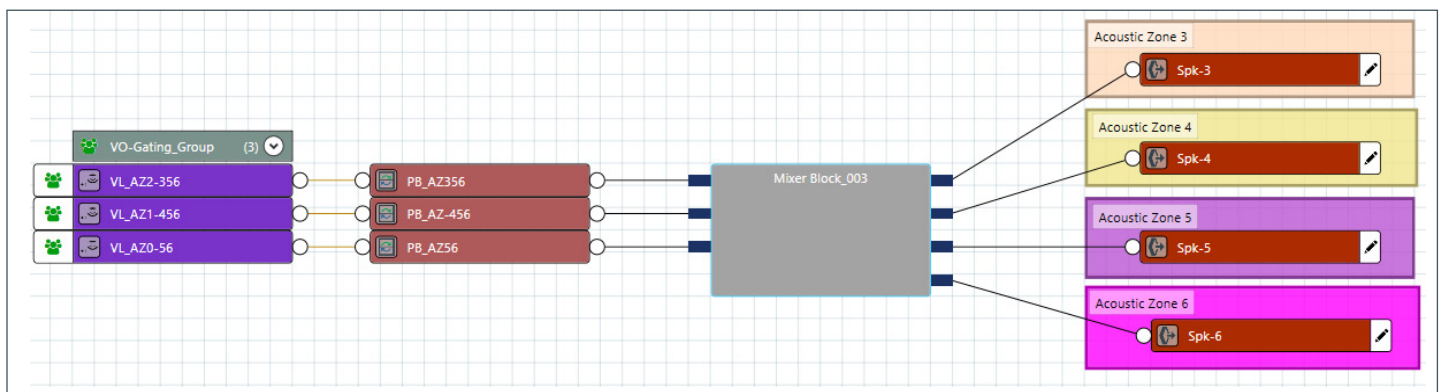

MatrixView

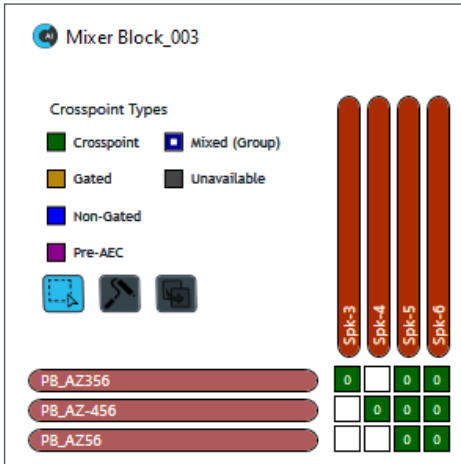

Now that we have the Voice Lift channels routed. We can incorporate the speakers, USB, Bluetooth interface and the Main BMA 360 Microphone audio channel. Here is what the example room design looks like when completed.

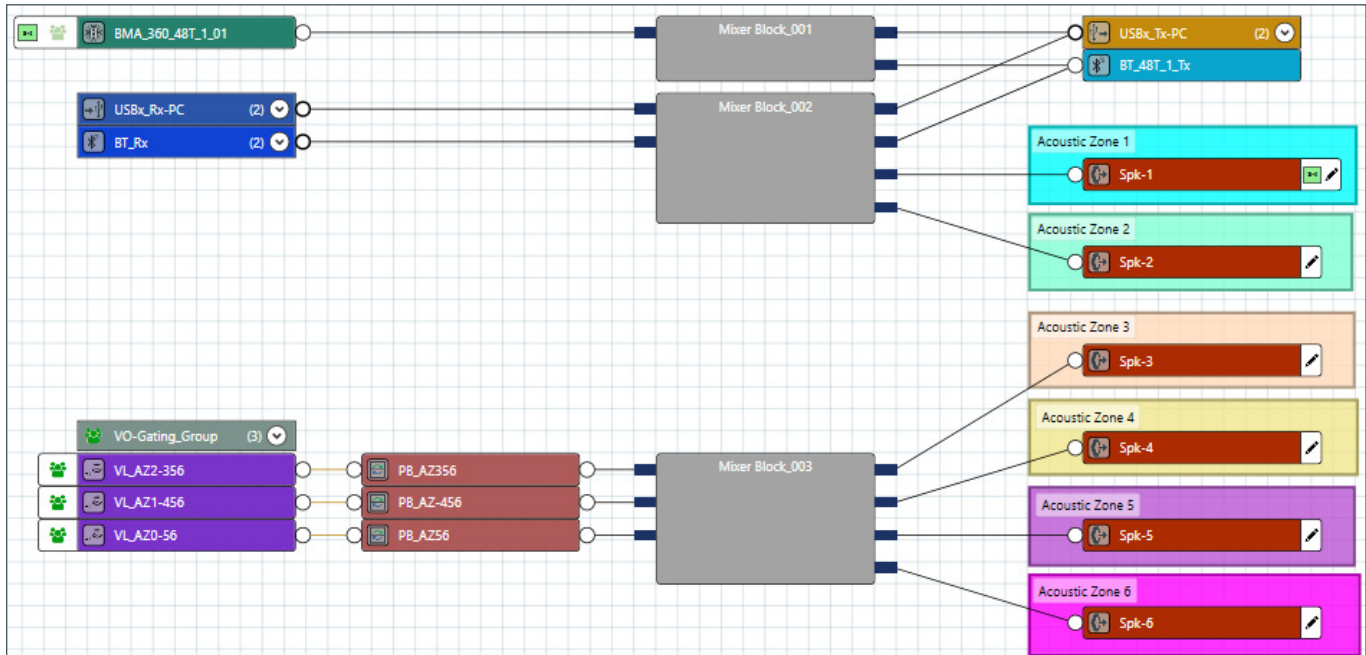

How do I tune my system?

A Voice Lift system is composed of a few adjustment and performance categories to consider:

A. System Gain vs. Acoustic Loss

This is the level of amplification applied to the talker’s voice in the room, minus the natural speaker to microphone loss of gain caused by acoustic dispersion in the physical room.

If there is more gain than loss, the system will be prone to feedback. These are the core “PAG/NAG” principles discussed in depth on the first pages of this document.

Strategic mixing of multiple microphone channels to

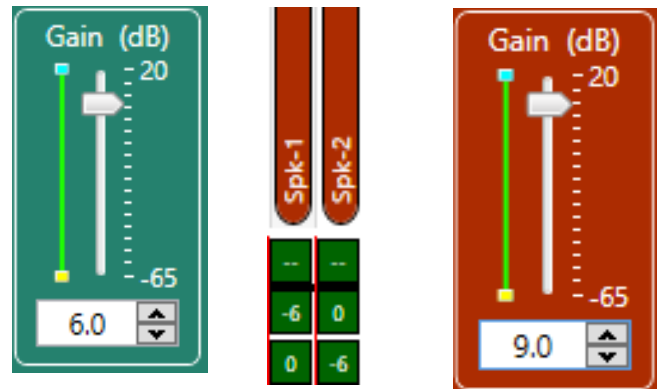

multiple speaker channels is one strategy to increase loss while maintaining the audio gain where it is needed in the room.

Using highly directional microphones, such as the BMA 360, to reduce speaker to mic audio is another.

B. Equalization

In a normal conference room, the rate of acoustic dispersion is not the same for all frequencies. Reducing frequencies, via EQ controls and/or Feedback Eliminator, that tend to feedback most readily can provide more overall gain before feedback and a better overall sound quality as well.

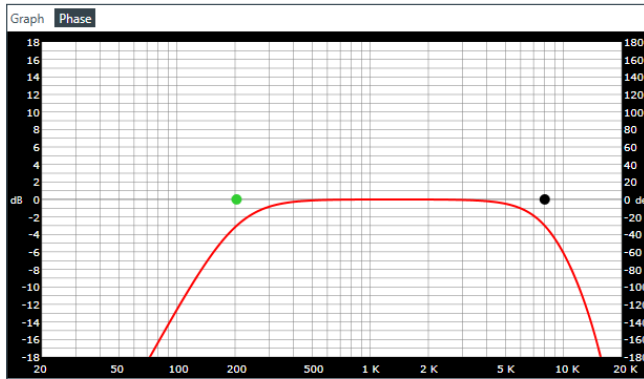

Automatic Setup

Run Setup State: Off

Number of Fixed Filters:

Target Gain Before Feedback:

Feedback Gain: 0.1 Total Nodes Used: 8

Affected Microphones

TrainingBP

Feedback Node Report

Type	Frequency	Q	Depth
Fixed	335.940	5.00	-12
Fixed	820.310	5.00	-6
Fixed	395.510	5.00	-3
Fixed	1468.750	5.00	-3
Fixed	570.310	5.00	-3
Fixed	3353.520	5.00	-3
Fixed	290.040	5.00	-3
Fixed	710.940	5.00	-3

C. Auto-mixing

Larger rooms tend to have many microphones. In a Voice Lift system, these microphones will increase system gain as each nearby microphone contributes audio to the mix. The solution is to detect and reduce the gain or “Gate Off” microphones that are determined to not be needed at any moment.

ClearOne has designed an extremely flexible Auto-mixer architecture that allows independent Gating parameters for the Voice Lift process separately from the, generally softer, Gating needs of audio conferencing.

Limiting the allowed number of open microphones to “1” and raising Off Attenuation values for VL Channels will decrease feedback and also reduce noise levels.

Gating Group Properties : VO-Gating_Group

First Mic Priority: On Off

Max Number Mics On :

Last Mic Priority :

NOM:

Gate Settings

Gate Mode:

Settings

Gate Ratio (dB)

Hold Time

Off Attenuation

Decay Rate (dB/s):

Our design is done! For additional resources, training, and information, please visit our website at www.clearone.com.

SALES AND INQUIRIES

Headquarters

5225 Wiley Post Way
Suite 500
Salt Lake City, UT
84116

US & Canada

Tel: +1.801.975.7200
global@clearone.com

International

Tel: +1.801.975.7200
global@clearone.com

Sales

Tel: +1.801.975.7200
sales@clearone.com

Tech Support

Tel: +1.801.974.3760
techsupport@clearone.com