

BMA CT



The BMA CT is a patented ceiling tile beamforming microphone array that blends in perfectly with today's drop ceilings. Built-in acoustic echo cancellation, noise cancellation, and beam selection eliminate the need for per-beam processing in a DSP mixer - requiring fewer DSP mixer resources.

- > Integrated features can significantly reduce system design complexity, simplify installation, consume less rack space, and lower cost.
- > Single workflow for configuration using Pro Console® software. No need to program separate components: Ethernet switch, BMA CT, Dante® controller, and DSP mixer.
- > Daisy-chain up to three ceiling tiles via P-Link for larger conference setups – for simpler wiring and longer distances compared to networked “home run” connections.
- > ClearOne's BMA technology is protected by at least a dozen patents and pending patent applications.
- > Each ceiling tile microphone array supports long distance P-Link mode with 200 m / 650 ft between tiles, for a total cable reach of 600 m / 1950 ft
- > Supports three different ceiling grid types: 24-inch, 600 mm, and 625 mm; as well as hard-ceiling mounts.
- > It's all about the ClearOne architecture!

APPLICATIONS

- Audio conferencing
- Video conferencing

WORKSPACES

- Boardrooms
- Conference rooms
- Training centers
- Lecture halls
- Courtrooms



More Power Inside

Built-in 2 x 10 Watt into 8-ohm power amplifier conveniently drives loudspeakers.

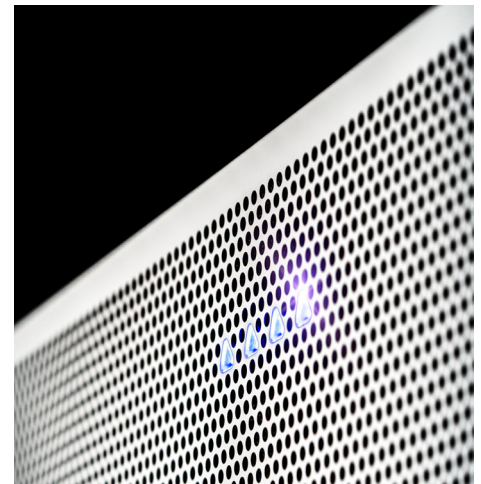

Free to Move Around the Room

Adaptive steering (think of it as smart switching) - no need to adjust individual beams - for impeccable room coverage.

It's All About the Architecture!™

MICROPHONES

BMA CT

Connections

BMA CT I/O CONNECTIONS

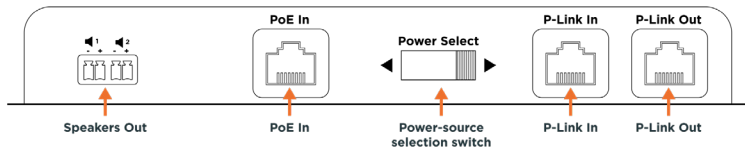

Orientation

ORIENT LEDS TOWARDS EITHER END OF THE TABLE

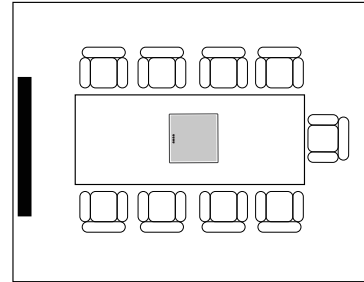

Connection Diagrams

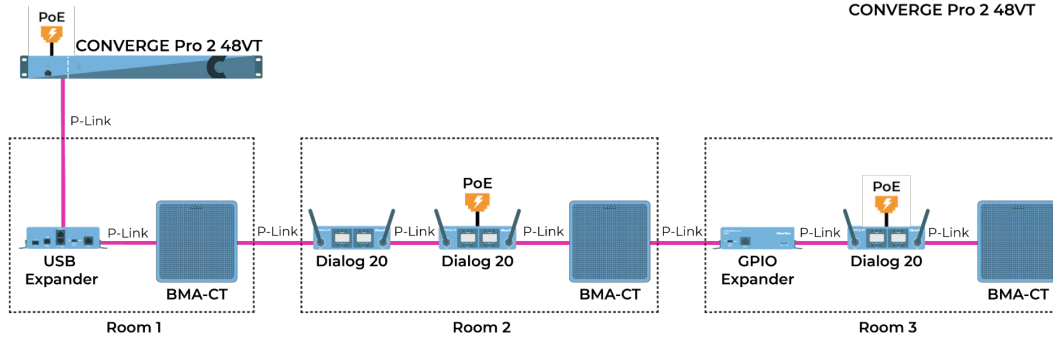
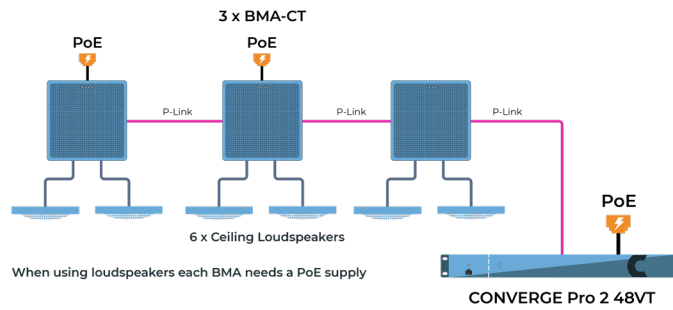

P-Link carries up to 16x16 audio channels

Standard Operating Mode

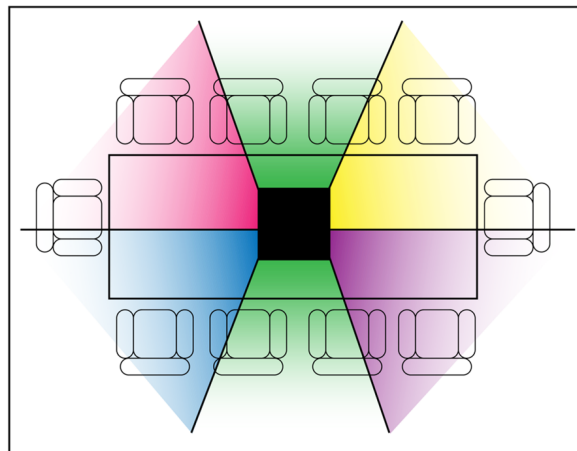
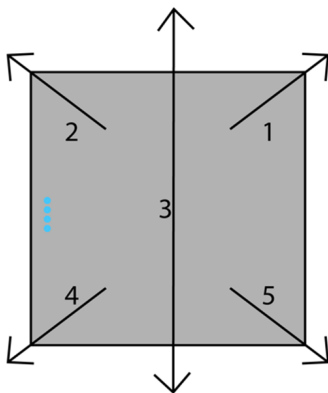

BMA CT

Diagrams

SIDE VIEWS

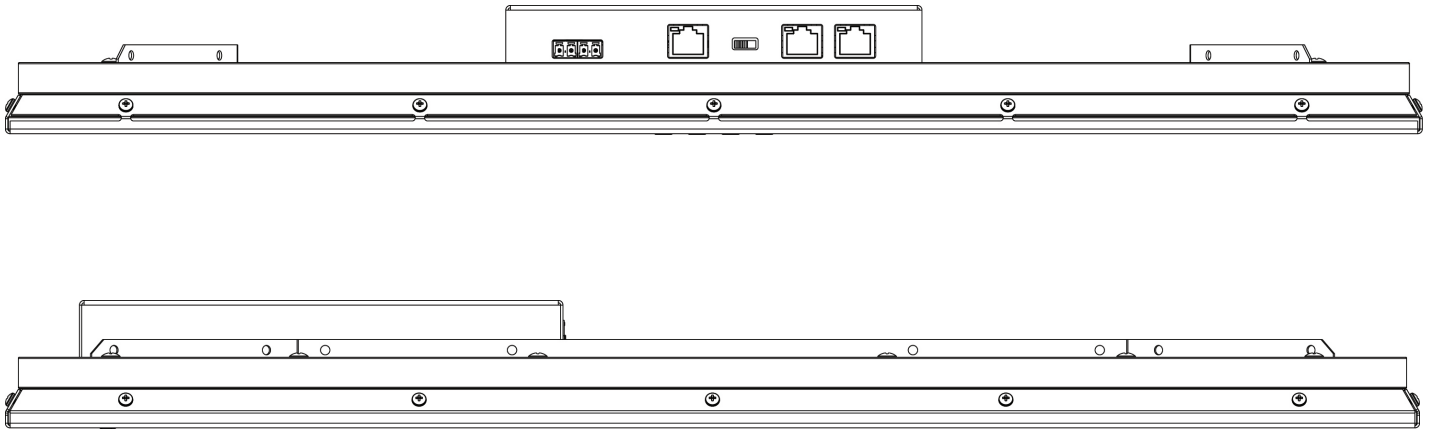

BACK VIEW

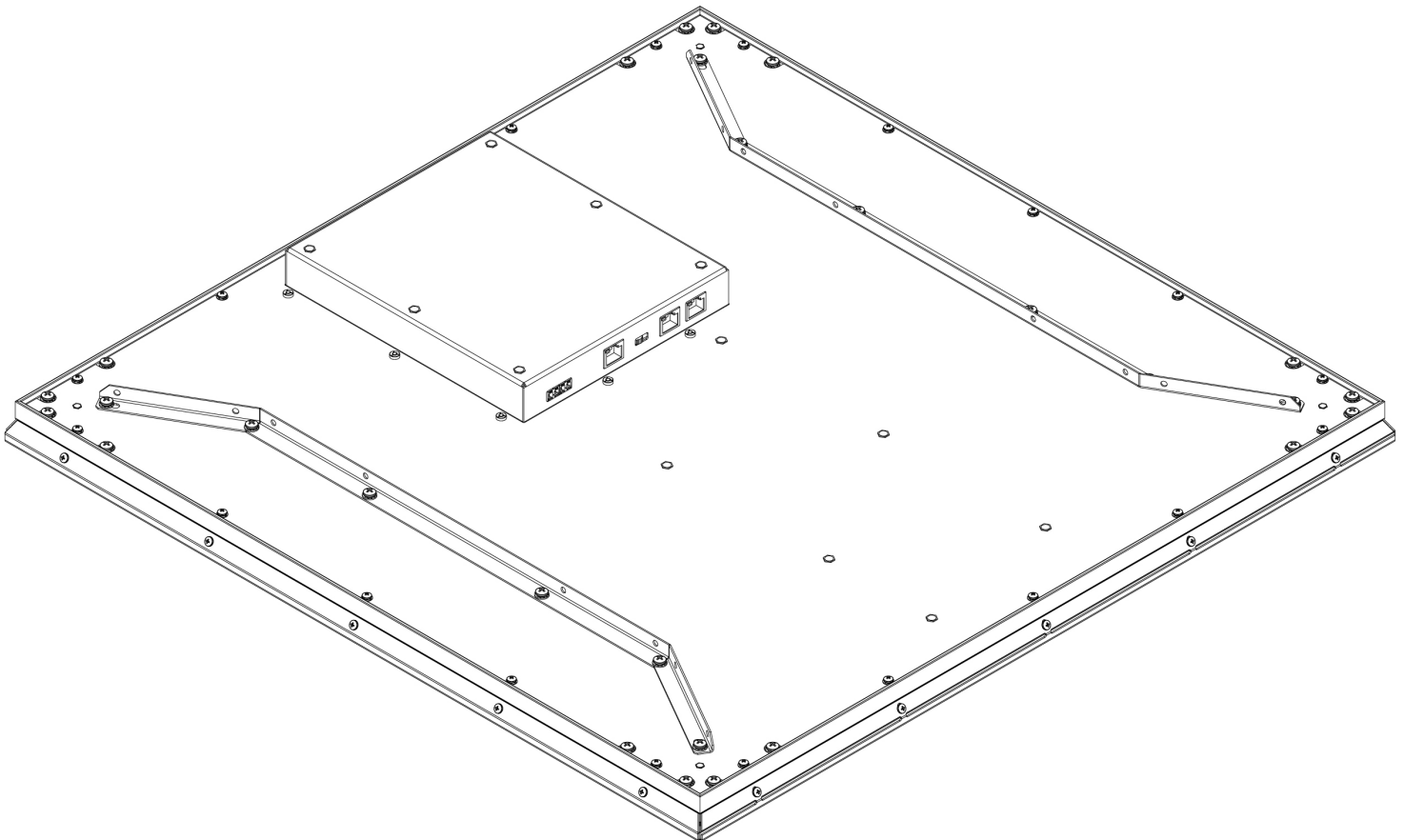

BMA CT

Diagrams

3RD-PARTY HARD-CEILING MOUNT OPTIONS - RAB LIGHTING

RECESSED MOUNT RMKPANEL2X2

Dimensions

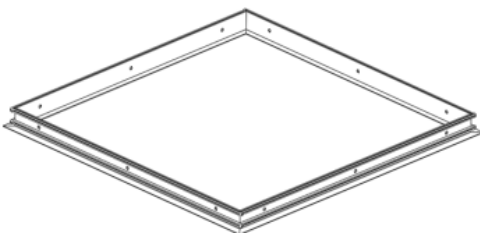
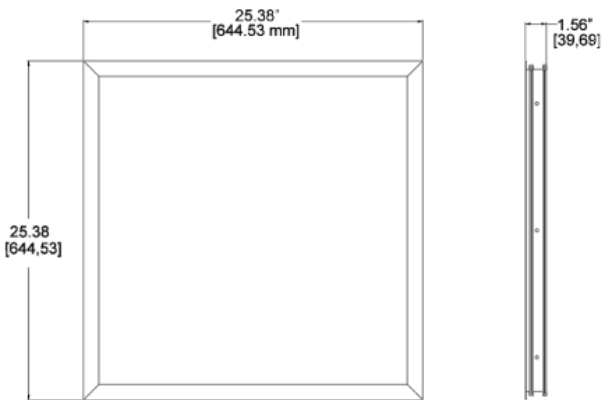

ROUGH IN CUT OUT
24 5/8" X 24 5/8"

SURFACE MOUNT SMKEZPAN2X2

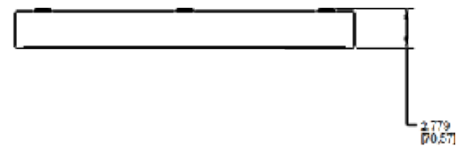
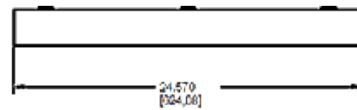
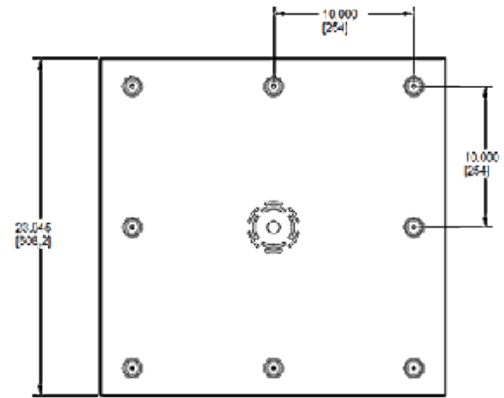

BMA CT

24 MICROPHONES

- Number of Beams: Two patterns, either 5 or 6 beams
- Polar Pattern: Custom
- Frequency Response: 150Hz – 16kHz, +/- 3dB
- Dynamic Range: 150Hz – 16kHz, > 70dB

AMPLIFIER OUTPUT

- Uses P-Link channels and C-Link channels based on configuration
- Type: 5.08mm Black Header, Male, Phoenix type Euroblock
- Audio: 2 channels
- Output Power: 2x10W Max, 8Ω load*
- Frequency Response: 20Hz – 22kHz @ +10dBu, +/- 0.5dB
- THD + Noise: 20Hz – 22kHz @ +10dBu, 1W, < 0.2%
- Dynamic Range: 20Hz – 22kHz @ +20dB, > 102dB, with 20kHz digital low pass filter
- Crosstalk: Channel to Channel, stimulus at +20dBu receptor 10W output 8Ω load, 20Hz – 22kHz, < -60dB

LED

- 4 LED indicators on one end of unit:
- Mute/Un-mute configuration with 8 color options, two blink patterns and warning indications

CONFIGURATION

- Beam enable/disable
- Acoustic Echo Cancellation (AEC) on/off
- Noise Cancellation (NC) on/off
- Filters:
 - All Pass
 - Low Pass
 - High Pass
 - Notch
 - PEQ
- Automatic Level Control (ALC) on/off
- Gain adjust
- Mute on/off
- Auto gate/Manual gate

P-LINK PERIPHERAL BUS

- P-Link In & Out: Proprietary Network
- Ports Type: RJ-45
- Cable: RJ45 Cat5e, Cat6, Expandable
- Distance: Up to 650 ft.
- Daisy-Chain:
 - Up to 3 Array units and additional P-Link compatible devices with each supported CONVERGE Pro 2 unit in the same chain
 - Up to 6 array units in the same P-Link chain with 2 supported CONVERGE Pro 2 units connected through C-Link
- Long Distance P-Link:
 - Increases P-Link distance from 200 ft. to 650 ft.; (200M) max cable distance between any two units; Cat6, 550 MHz, 23 AWG, solid conductor cable;
 - Do not use Copper Clad Aluminum (CCA) cable

POWER SELECTION SWITCH

- Type: Slide Switch
- Slide toward P-Link to power device by P-Link
- Slide toward PoE to power device by PoE Injector

CONFIGURATION & ADMINISTRATION SOFTWARE

- Pro CONSOLE® Software

MOUNTING

- Ceiling mount (24" or 600mm drop-ceiling grid)

POWER & THERMAL

- Power Type: PoE
- Port Type: RJ-45
- Power Source: PoE Injector or equivalent
- PoE: IEEE 802.3at compliant devices providing 56V and 640 mA (36 W).
- P-Link In - Mode B
- PoE In - Mode A and Mode B
- *BMA CT requires its own PoE (IEEE 802.3 at compliant) if 2x10W speakers are driven
- Power Consumption:
 - 100-240VAC, 50/60Hz
 - 9.1 Watt typical without speaker amp
 - 38W at max power 1kHz (2 x 10W)
 - Thermal: 130 BTU/Hr at max power
 - Operating Temperature: 14° F/-10° C to 104° F/40° C ambient temperature

MICROPHONES

BMA CT

DIMENSION & WEIGHT (WxHxD)

- 24" BMA CT:
23.72 x 23.72 x 2.13" (602.5 x 602.5 x 54.1mm)
- 600 mm BMA CT:
592.5 x 592.5 x 54.1 mm (23.33 x 23.33 x 2.13")
- Unit Weight: 7.7lbs (3.5kg)
- Shipping Weight: 11.5lbs (5.2kg)

SUPPORTED CONVERGE® PRO 2

- 910-3200-001 CONVERGE Pro 2 128
- 910-3200-001-D CONVERGE Pro 2 128D
- 910-3200-002 CONVERGE Pro 2 128T
- 910-3200-002-D CONVERGE Pro 2 128TD
- 910-3200-003 CONVERGE Pro 2 128V
- 910-3200-003-D CONVERGE Pro 2 128VD
- 910-3200-009-D CONVERGE Pro 2 128VTD
- 910-3200-005 CONVERGE Pro 2 48T
- 910-3200-006 CONVERGE Pro 2 48V
- 910-3200-008 CONVERGE Pro 2 48VT
- 910-3200-008-D CONVERGE Pro 2 48VTD
- 910-3200-004 CONVERGE Pro 2 120

ACCESSORIES

- 910-3200-202 PoE Power supply kit for BMA CT
- 910-3200-204-50 50 ft RJ45 CAT6 Cable
- 910-3200-204-100 100 ft RJ45 CAT6 Cable
- 910-3200-204-150 150 ft RJ45 CAT6 Cable
- 910-3200-204-200 200 ft RJ45 CAT6 Cable
- 910-3200-205-AI Brackets, convert 600 to 625 mm
- 910-3200-205-CB BMA CT Conduit Box

MOUNTS FOR NON-TILE CEILINGS

- 910-3200-210 BMA Surface-Mount Kits 24in
- 910-3200-210-I BMA Surface-Mount Kits 600mm
- 910-3200-211 BMA Recessed-Mount Kits 24in
- 910-3200-211-I BMA Recessed-Mount Kits 600MM

PART NUMBERS

- 910-3200-205: 24" White BMA CT
- 910-3200-205-I: 600 mm White BMA CT

SALES AND INQUIRIES

Headquarters

5225 Wiley Post Way
Suite 500
Salt Lake City, UT 84116

US & Canada

Tel: 801.975.7200
Fax: 801.303.5711

International

Tel: +1.801.975.7200
global@clearone.com

Sales

Tel: 801.975.7200
sales@clearone.com

Tech Support

Tel: 801.974.3760
tech.support@clearone.com