

BMA 360D

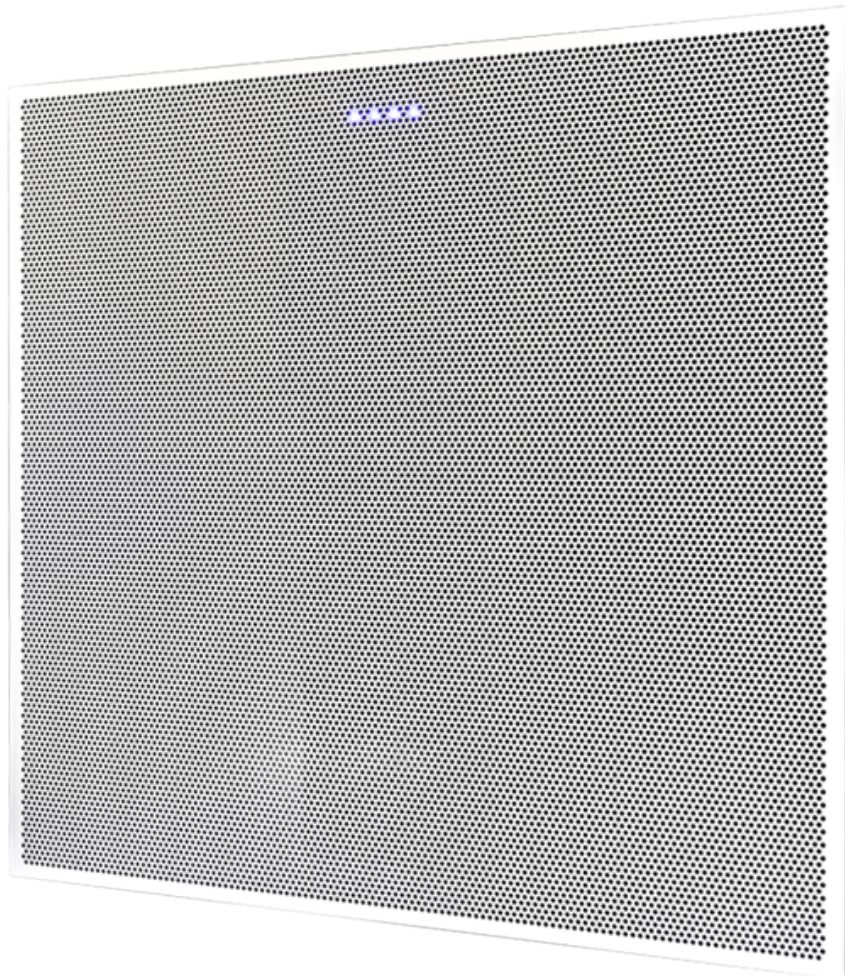

ClearOne Contacts

Headquarters

5225 Wiley Post Way Suite 500
Salt Lake City, UT 84116

Sales

Tel: +1.801.975.7200
sales@clearone.com

Headquarters

Tel: +1.801.975-7200

Technical Support

Tel: +1.801.974.3760
audiotechsupport@clearone.com

Notices

© 2025 ClearOne, Inc. All rights reserved.
Information in this document is subject to change without notice.
Document: DOC-0578-001v1.1 January 2025

Important Safety Instructions

1. Read and follow all instructions.
2. Keep these instructions.
3. Do not use these devices near water.
4. Clean only with dry cloth.
5. Do not block any ventilation openings. Install in accordance with manufacturer instructions.
6. Do not install near any heat sources such as radiators, heat registers, stoves, or other apparatus (including amplifiers) that produce heat.
7. Do not defeat the safety purpose of the polarized or grounding-type plug. A polarized plug has two blades with one wider than the other. A grounding type plug has two blades and a third grounding prong. The wide blade or the third prong are provided for your safety. If the provided plug does not fit into your outlet, consult an electrician for replacement of the obsolete outlet.
8. Protect the PoE injector's power cord from being walked on or pinched particularly at plugs, convenience receptacles, and the point where they exit from the apparatus.
9. Only use attachments/accessories specified by the manufacturer.
10. When a cart is used, use caution when moving the cart/apparatus combination to avoid injury from tip-over.
11. Unplug this apparatus during lightning storms or when unused for long periods of time.
12. Refer all servicing to qualified service personnel. Servicing is required when the apparatus has been damaged in any way, such as power-supply cord or plug is damaged, liquid has been spilled or objects have fallen into the apparatus, the apparatus has been exposed to rain or moisture, does not operate normally, or has been dropped.
13. Disconnect the apparatus from the AC mains with the mains plug. This plug shall remain readily operable.
14. Never push objects of any kind into this product through cabinet slots as they may touch dangerous voltage points or short out parts that could result in fire or electric shock.
15. This product can interfere with electrical equipment such as tape recorders, TV sets, radios, computers and microwave ovens if placed in close proximity.
16. Class 2 Wiring IS REQUIRED. Only qualified personnel should wire and install.
17. Underwriters Laboratories (UL) requires these safety notifications

Contents

Notices.....	i
1. Introduction	1
• The BMA 360D features the following.....	1
• Applications	1
2. Physical Installation.....	2
• Connect Speakers	2
• Important: Please note the following PoE requirements	2
• Install the BMA 360D with Seismic Cables	2
• Install the BMA 360D with Pole Mount	3
• Connect the BMA 360D to Your Network	4
• Network Configuration	4
3. PoE Requirements	4
4. Discovery.....	5
5. Dante Configuration	7
6. Dante Audio Routing	8
7. Configuration and Tuning Controls.....	12
• Speaker Bridge Mode and LED Settings.....	12
• SmartMix BMA Gain Setting	13
• SmartMix AEC and NLP	13
• SmartMix Noise Cancellation	14
• SmartMix Microphone and Speaker Filters	16
• Filter Type Description	16
• SmartMix Automatic Level Control (ALC)	17
• SmartMix AEC Reference.....	17

1. Introduction

The BMA 360D features the following:

- Deep Sidelobe Beamforming, DsBeam™, provides unparalleled sidelobe depth, below -40 dB, resulting in superior rejection of reverb and noise in difficult spaces for superb clarity and intelligibility.
- Precision beamforming to easily achieve distortion-free, full 360-degree coverage of any room shape and any seating arrangement using ClearOne Audio Intelligence™.
- 6G Acoustic Echo Cancellation (AEC) delivers unparalleled per-beam full-duplex audio performance. On-board audio algorithms, like noise reduction, filtering, and Automatic Level Control, can eliminate the need for per-beam processing in a DSP mixer – or greatly reduce DSP mixer resource requirements.
- Built-in, robust power amplifiers, configurable as 4 x 15 Watt or 2 x 30 Watt, provide flexibility for driving loudspeakers.
- ClearOne's breakthrough technologies, FiBeam, DsBeam, and 6G AEC combine to create VividVoice™, a significant advancement for professional conferencing.
- A Dante interface provides 12 unprocessed beam outputs for maximum flexibility when connecting to a multi-channel DSP, one SmartMix output provides automixing, AEC, and noise cancellation processing in a single output, four input channels feed the 4 speaker channels, and one input channel delivers the AEC reference.
- Integrated features significantly reduce system design complexity, simplify installation, consume less rack space, and lower system cost.
- Single workflow for configuration using CONSOLE® AI LITE software.
- Supports two different ceiling grid types: 24 IN and 600mm. It incorporates a VESA-mount hole pattern that supports pole mounting. Hard-ceiling mount adapter kits are also available.

Applications

- Audio conferencing
- Video conferencing Workspaces
- Conference rooms
- Boardrooms
- Courtrooms
- Classrooms
- Telemedicine theaters

2. Physical Installation:

Unpack the BMA 360D and inspect it carefully. If the shipment shows obvious signs of damage, retain the original box and packing material for inspection by the carrier. Contact the carrier immediately. ClearOne is not responsible for product damage incurred during shipment.

Connect Speakers

A good time to connect external speakers is before you install the BMA 360D in the ceiling. With speaker wire (not included), connect external speakers to the Phoenix Euroblock connectors.

The BMA 360D can be operated as 4 independent 15 Watt amplified channels, or in Bridged mode for 2 channel x 30 Watt configuration.



Important: Please note the following PoE requirements:

- When not utilizing the BMA 360D amplifiers, a 36 Watt PoE+ supply may be used.
- When using the BMA 360D amplifiers, a 90 Watt PoE+ + supply must be used.
- ClearOne recommends the following PoE power supply kits:
 - * ClearOne 36 Watt supply – PN# 910-3200-202
 - * ClearOne 90 Watt supply – PN# 910-3200-209

Install the BMA 360D with Seismic Cables

You can mount the BMA 360D in a suspended ceiling, held in place by the standard T-bar grid, with additional 1/8" diameter seismic cables (not included). For safety, ClearOne recommends attachment at the four points shown.

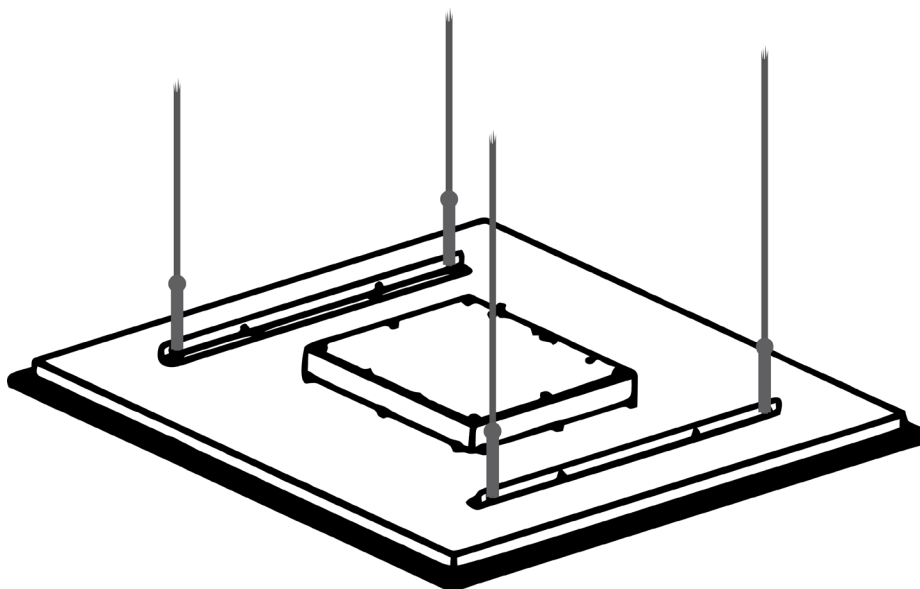

Install the BMA 360D with Pole Mount

The BMA 360D can be suspended from the ceiling using a horizontal VESA pole mount, commonly referred to as a projector ceiling mount. The BMA 360D back panel features a standard 100 x 100 mm VESA hole pattern with M4 screw holes. For proper installation, refer to the detailed instructions provided with your pole mount.

Note:

1. BMA microphone weight: 11.1 lbs (5 kg)
2. M4 screw (Maximum Length): M4 x 10 mm

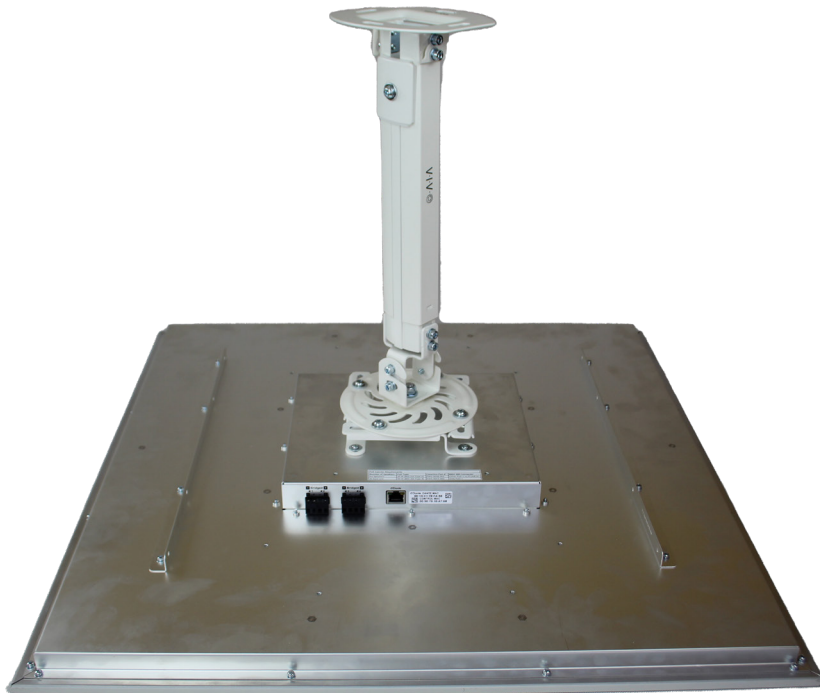

Connect the BMA 360D to Your Network

Connect the BMA 360D to your Dante enabled network and PoE power supply. It is recommended to use ClearOne certified PoE injectors in-line with your BMA 360D.

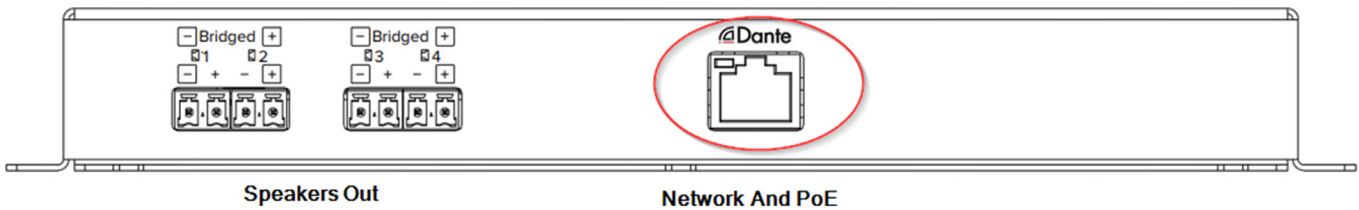
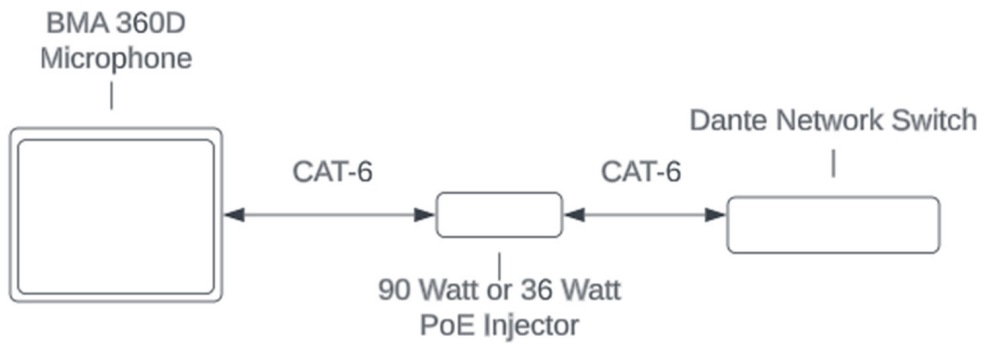

Network Configuration

The BMA 360D has a single Network connection which serves both IP Configuration and Dante audio connection roles. To perform initial configuration, connect both the BMA 360D and your PC to a DHCP enabled network. You may then discover and configure the BMA 360D using ClearOne’s CONSOLE AI Lite Software. Configuration and control of the BMA 360D is achieved through ClearOne’s CONSOLE AI Lite software.

Please visit us at <https://www.clearone.com/console-ai-lite-configuration-software-0> for CONSOLE AI Lite downloads and details.

3. PoE Requirements:

Power delivery to the BMA 360D is exclusively via PoE injection. If speakers are not connected to the BMA 360D, a 36 Watt PoE+ supply (PoE 802.3AF) can be used. When one or more speakers are connected to the BMA 360D, a PoE++ (802.3bt) 90 Watt injector must be used. Note that the detected available PoE power is denoted in CONSOLE AI Lite in the Admin section. If a 90 Watt supply is detected, the PoE Status will be denoted as “PoE++”

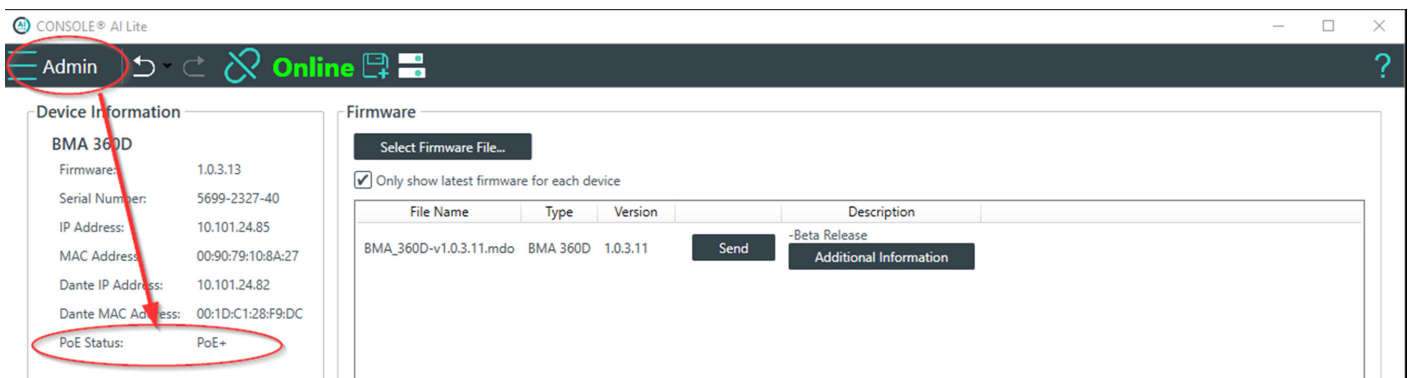

4. Discovery:

CONSOLE AI Lite will discover all ClearOne equipment on the network that can be controlled via CONSOLE AI Lite. These available devices will be displayed in the Discovered Devices panel:

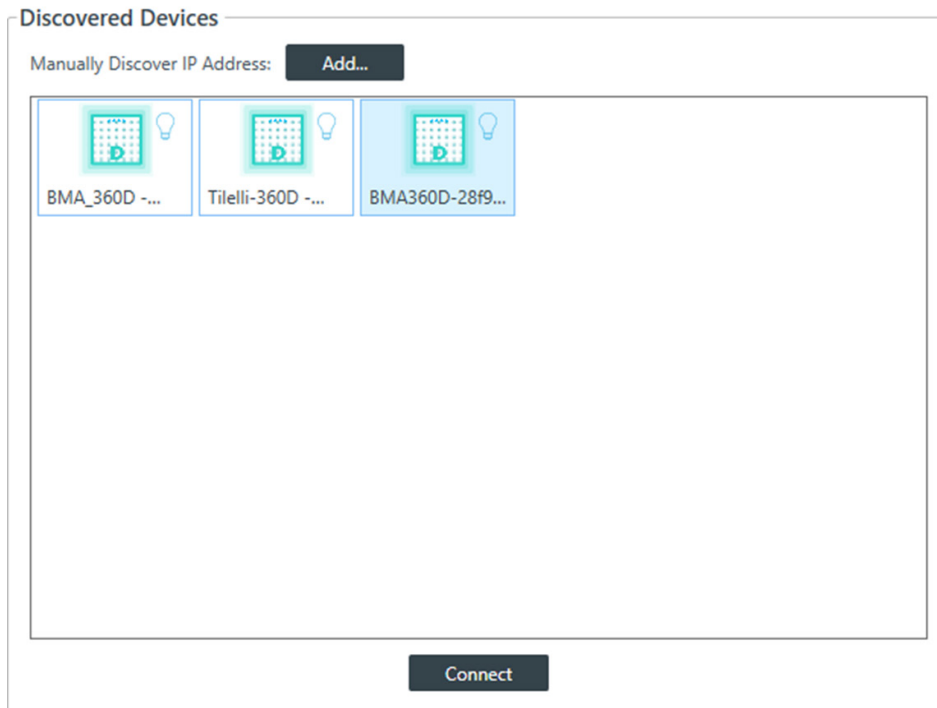

If multiple BMA 360Ds are present on the network, you can identify each by clicking on the Locate lightbulb icon. This will cause the corresponding physical BMA 360D's LED bar to flash green until the Locate icon is clicked again, or the Locate Timeout period has expired.

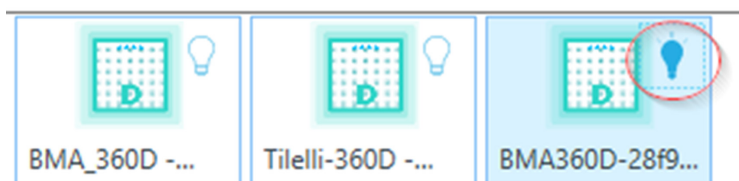

Once connected, navigate to the Device Settings window to perform any modification, or confirm your network settings:

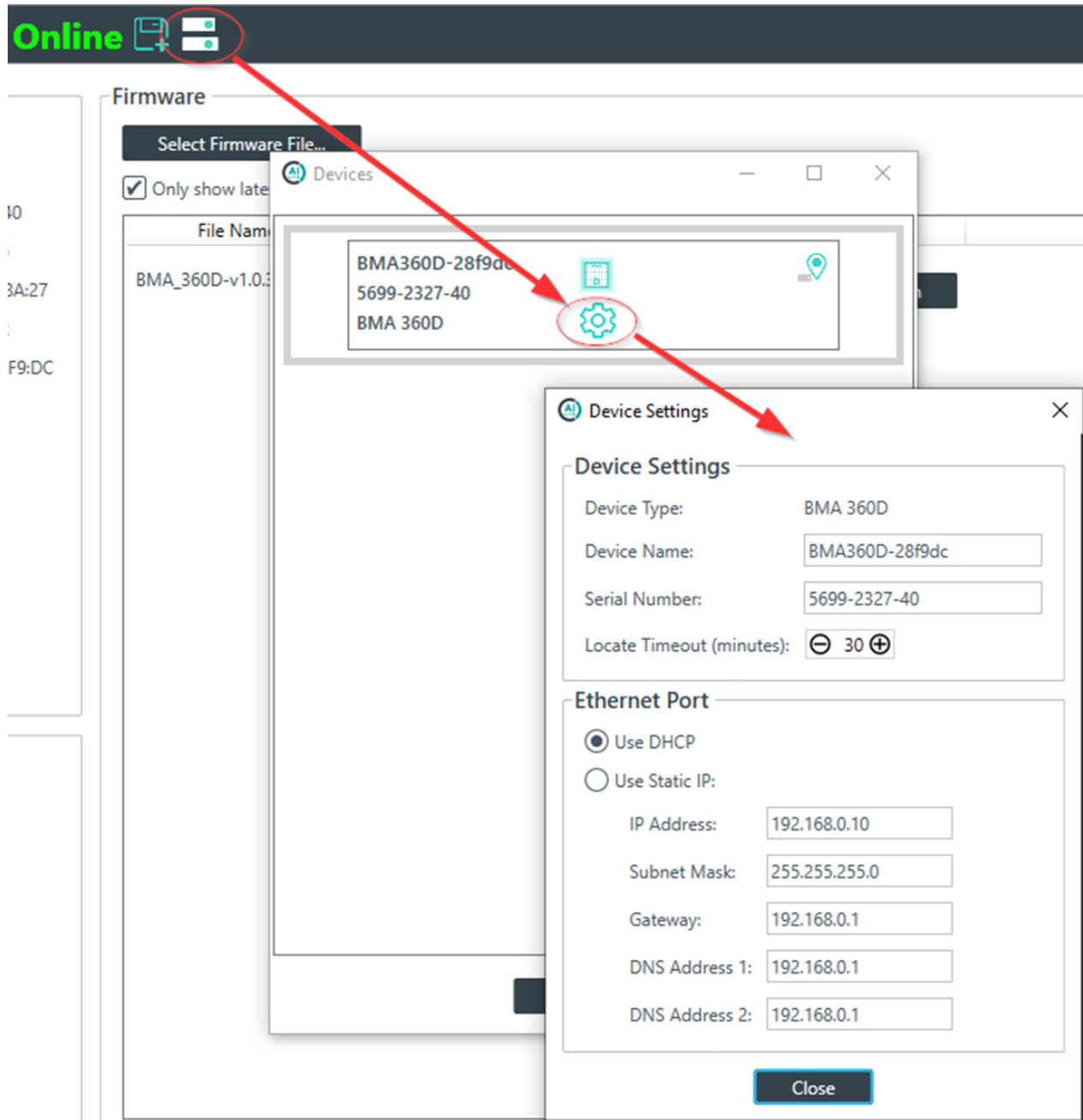

5. Dante Configuration:

The Dante IP address and Dante MAC address can be found in CONSOLE AI Lite under the Admin>Device Information panel.

Device Information

BMA 360D

Firmware:

Serial Number: 5699-2327-40

IP Address: 10.101.24.85

MAC Address: 00:90:79:10:8A:27

Dante IP Address: 10.101.24.82

Dante MAC Address: 00:1D:C1:28:F9:DC

PoE Status: PoE+

Audio routing to and from the BMA 360D is done via Dante Controller. Be sure that you have the BMA 360D and at least one other Dante enabled device, such as a DSP or Dante Virtual Soundcard attached to your Dante network prior to beginning configuration and routing. Use the Dante Controller software on your computer to verify that your BMA 360D appears on the Dante network’s device list with the Device Name assigned in the Device Settings panel.

Dante Controller - Network View

File Devices View Help

Routing **Device Info** Clock Status Network Status Events

Device Name	Model Name	Product Version	Dante Version
BMA360D-28f9dc	BMA 360D	1.0.1	4.2.3.8
BMA_360D	BMA 360D	1.0.1	4.2.3.8
CONNECT-049a26	CONNECT One	1.0.2	3.7.0.24
CPRO2-0e86e6	CONVERGE PRO 2	1.0.3	3.8.2.1
CPRO2-0e8a44	CONVERGE PRO 2	1.0.3	3.8.2.1

Your BMA 360D is now successfully connected to the Dante network and you can now route audio between your device and other Dante-enabled devices on the same network efficiently and with high audio quality.

6. Dante Audio Routing:

The BMA 360D Dante input and output channel options are designed to meet a variety of conference and voice lift needs. The graphic below outlines audio connection options for both microphone audio to the Dante network, as well as audio from the Dante network delivered to the BMA 360D's built in 4 channel amplifier.

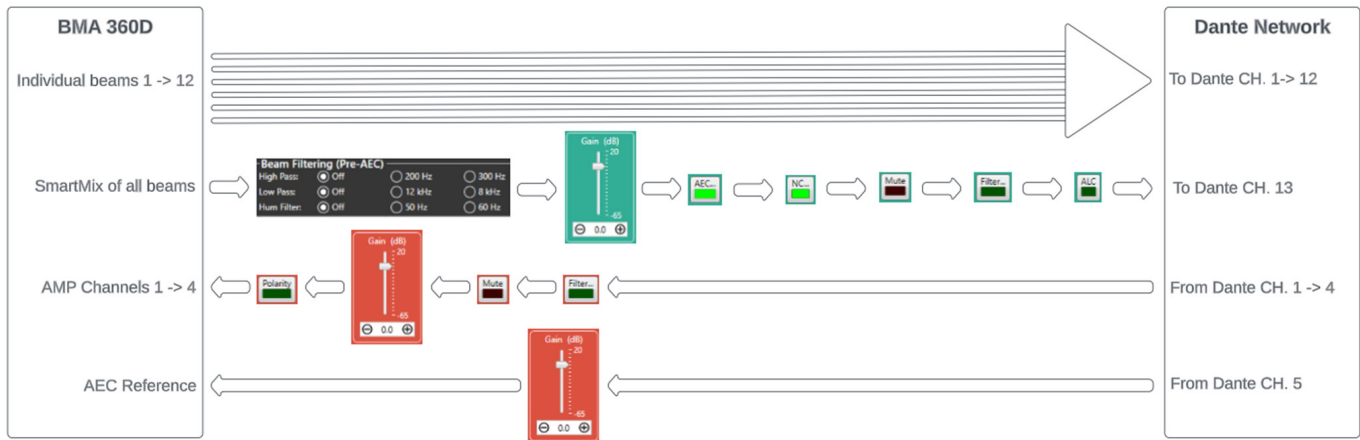

Use the Dante Controller software to configure audio routing between your device and other Dante-enabled devices on the network. This software is available from the Audinate webpage: www.audinate.com/products/software/dante-controller

For detailed audio control and/or voice lift enabled designs, independent feeds from each individual beam are available via Dante output channels 1-12 from the BMA 360D. These output channels have no gain, mute or volume control processing and are ideal for interfacing the BMA 360D with a Dante enabled audio processor.

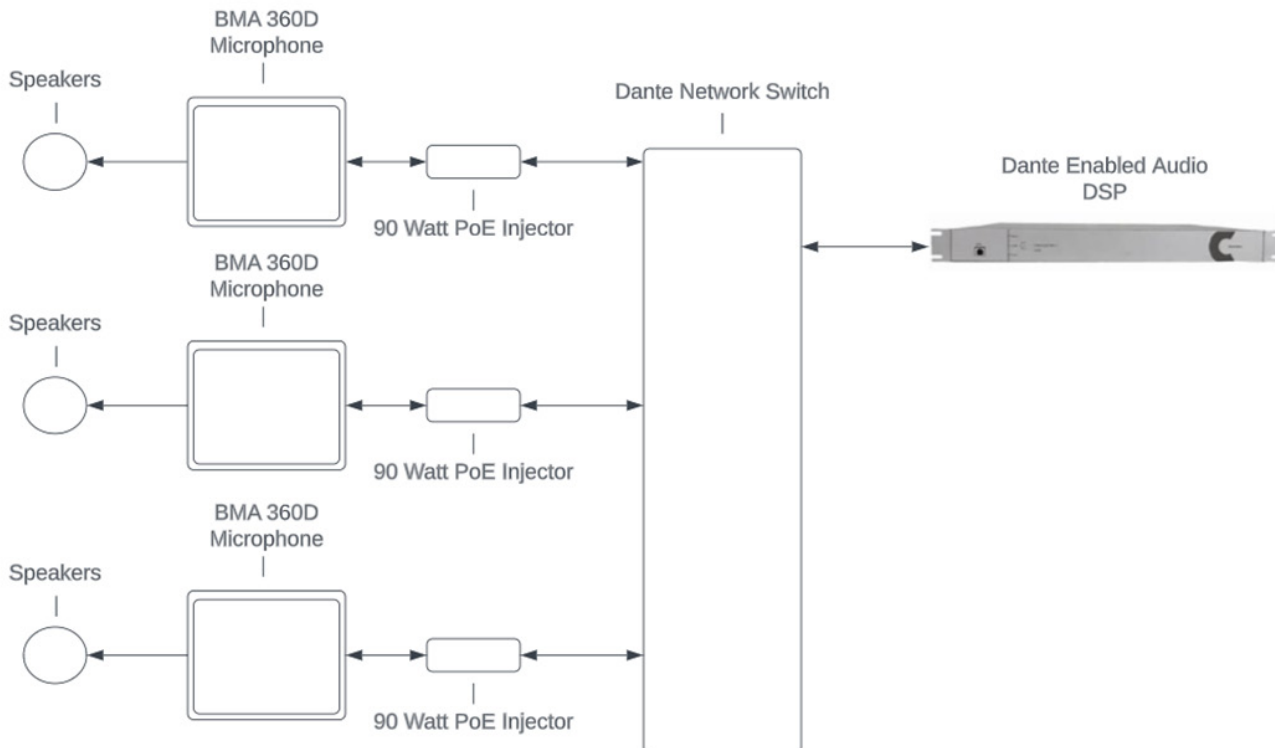

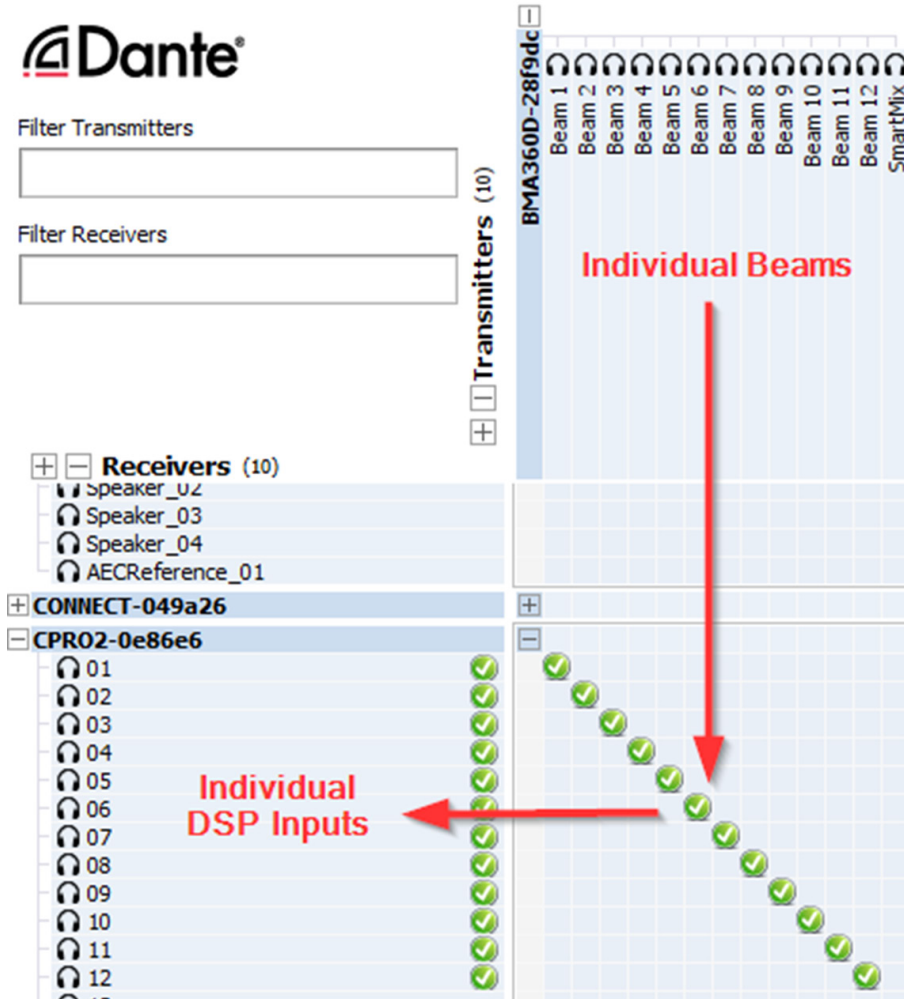

For simple room designs, utilize the SmartMix output 13 with integrated AEC, noise cancellation, filtering and zone mixing features. Utilizing the SmartMix microphone output and the built in amplifier channels, a complete system for cloud conferencing can easily be achieved. Below is a routing example using the Dante Virtual Soundcards (DVS) software on a PC for cloud conferencing. This example also utilizes the BMA 360D 4 channel amplifier for in room audio.

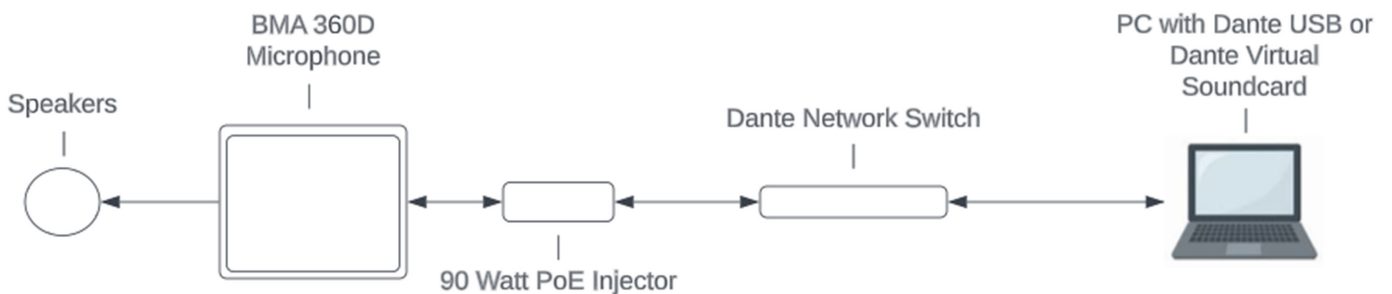

Dante Controller - Network View

File Devices View Help

Primary Leader Clock: C

Routing Device Info Clock Status Network Status Events

Filter Transmitters

Filter Receivers

Transmitters (11)

Receivers (11)

BMA_360D

- Speaker_01
- Speaker_02
- Speaker_03
- Speaker_04
- AECReference_01

CONNECT-049a26

CPR02-0e86e6

CPR02-0e8a44

CPR02-0e8a78

CPR02-0f7d84

CPR02-11aae6

FEED4

L8111-Ryan

- 01
- 02
- 03

SmartMix Channel 13

DVS Output on PC

BMA 360D Amp x4

DVS input on PC

Note: That when using the SmartMix output, the AEC reference connection must also be used for proper Acoustic Echo Cancellation performance.

Dante Controller - Network View

File Devices View Help

Primary Leader Clock: (

Routing Device Info Clock Status Network Status Events

Dante

Filter Transmitters
[]

Filter Receivers
[]

Transmitters (11)

- BMA360D-28f9dc
 - Beam 1
 - Beam 2
 - Beam 3
 - Beam 4
 - Beam 5
 - Beam 6
 - Beam 7
 - Beam 8
 - Beam 9
 - Beam 10
 - Beam 11
 - Beam 12
 - SmartMix
- BMA_360D
- CONNECT-049a26
- CPR02-0e86e6
- CPR02-0e8a44
- CPR02-0e8a78
- CPR02-0f7d84
- CPR02-11aae6
- FEED4
- L8111-Ryan
 - 01
 - 02
 - 03

Receivers (11)

- BMA_360D
 - Speaker_01
 - Speaker_02
 - Speaker_03
 - Speaker_04
 - AECReference_01
- CONNECT-049a26
- CPR02-0e86e6
- CPR02-0e8a44
- CPR02-0e8a78
- CPR02-0f7d84
- CPR02-11aae6
- FEED4
- L8111-Ryan
 - 01
 - 02
 - 03

Echo Reference Audio (Red arrow pointing to AECReference_01)

DVS Output on PC (Red arrow pointing to L8111-Ryan 01)

7. Configuration and Tuning controls in CONSOLE AI Lite

Speaker Bridge Mode and LED Settings

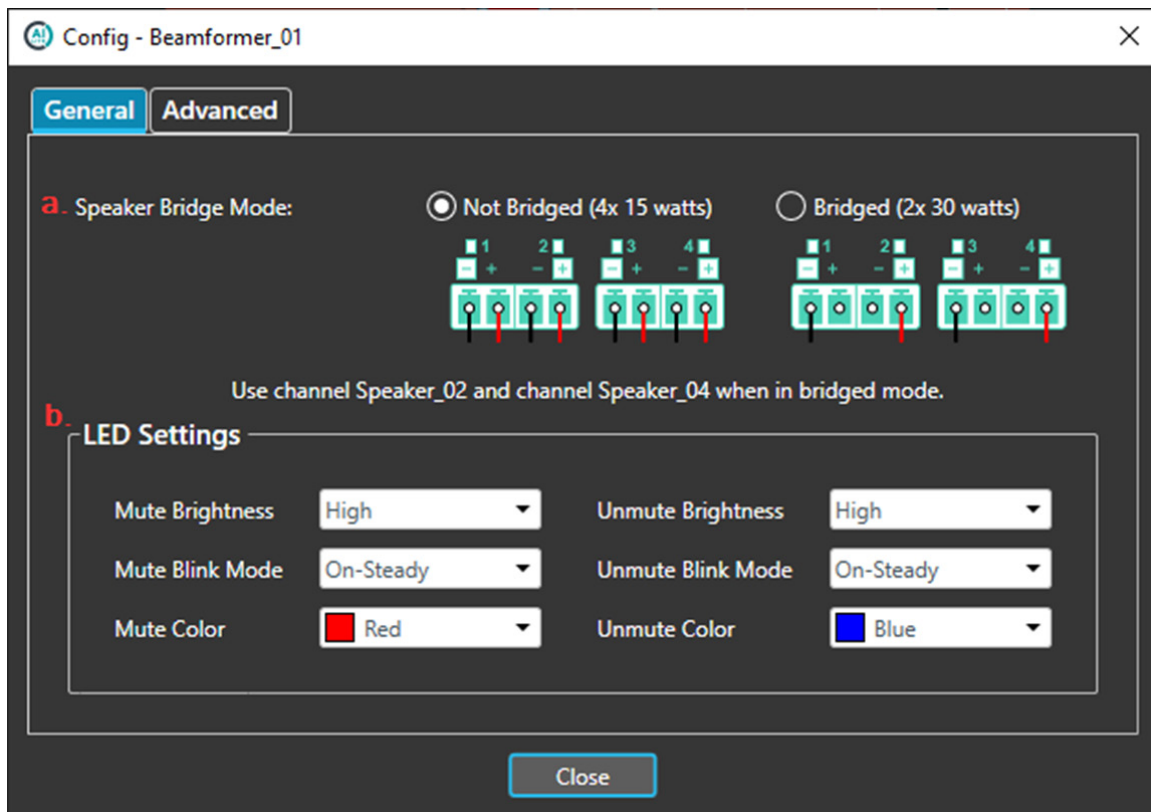

- Speaker Bridge Mode allows the selection of either fully individuated 4 x 15 Watt Amplifier operation or 2 x 30 Watt Bridged mode operation.
- LED Settings allow for customization of LED color, blink and brightness when in Muted or Unmuted states.

SmartMix BMA Gain Setting

You can set the gain level in 3 ways:

- Drag the slider (a).
- Type a value in the text box (b).
- Tap or click the incrementer and decrementer buttons beside the text box (b) to adjust the value.

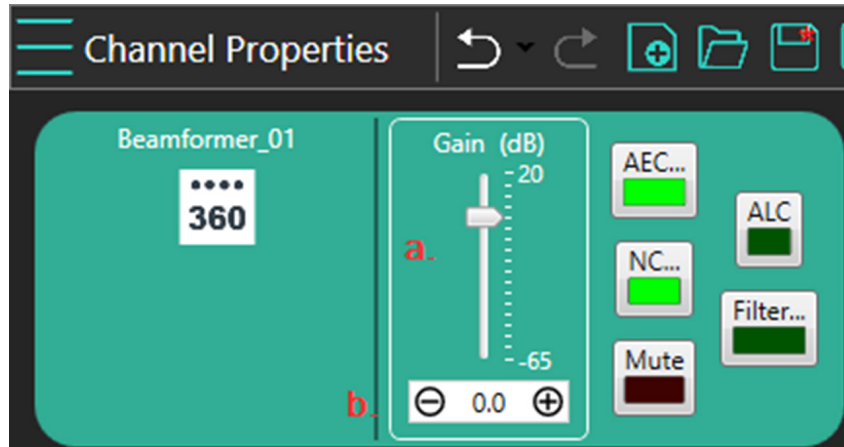

Note: Gain controls, Mute and Filtering options only apply to the SmartMix Dante Channel 13 output and do not affect the individuated Dante Beam output Channels 1-12.

SmartMix AEC and NLP

AEC (Acoustic Echo Cancellation) reduces or removes acoustical echo from an input signal to improve audio clarity.

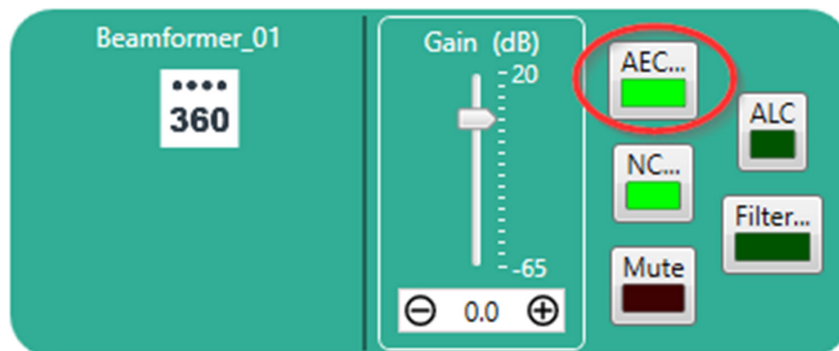

The AEC function provides full bandwidth (20Hz to 22kHz) echo filtering of the microphone signal. It uses a reference source (Dante input 5) which should include a mix of all far end participant receive audio that is being delivered to the room speakers.

Non-linear Processing (NLP) increases the power of echo cancellation for challenging acoustical environments.

You can select the following:

- Whether or not you want to use AEC. Tap or click the checkbox (a) if you want to use AEC.
- The level of aggressiveness. Tap or click the appropriate radio button (b).



Note: AEC processing is only available for the SmartMix Dante output channel 13 from the BMA 360D.

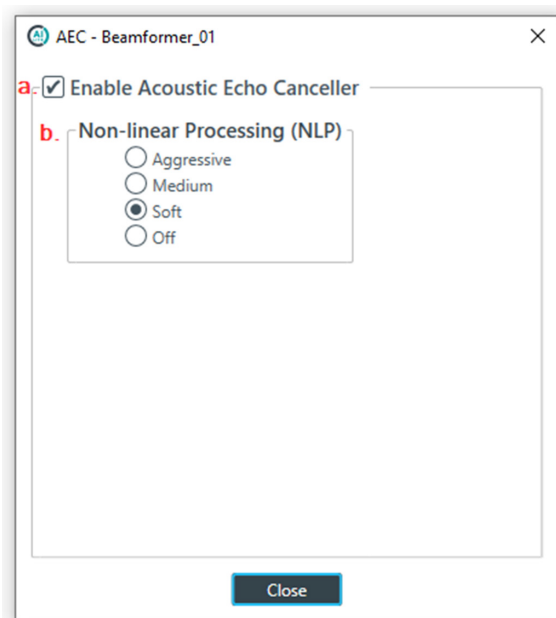

SmartMix Noise Cancellation

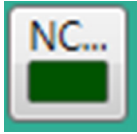

Noise Cancellation removes ambient (background) noise from an input signal, with no noticeable degradation in signal quality. To enable noise cancellation, tap or click the Enable Noise Canceller check box. You can change the cancellation depth with any of the following methods:

- Drag the slider (a).
- Type a value in the text box (b).
- Tap or click the incrementer and decrementer buttons beside the text box to set the value (c).

 **Note:** Noise Cancellation processing is only available for the SmartMix Dante output channel 13 from the BMA 360D.

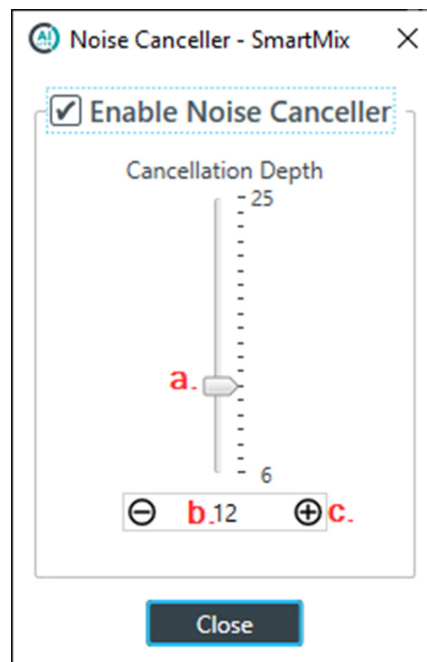

SmartMix Microphone and Speaker Filters

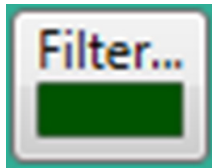

Filters enable you to shape the audio signals from microphone inputs channels and to speaker output channels for improved audio quality. You can add up to four filters to a microphone or speaker channel. Available filter types include the following:

Filter Type Description

- All Pass Frequency range is 20Hz to 20kHz. All pass changes the phase of the audio signal at the set frequency.
- High Pass Selectable frequency cutoff is 20Hz to 20kHz. Rolloff is 12dB/octave. Level is fixed at 0dB.
- Low Pass Selectable frequency cutoff is 20Hz to 20kHz. Rolloff is 12dB/octave. Level is fixed at 0dB.
- Notch Center frequency range is 20Hz to 20kHz. Bandwidth is from 0.05 to 5.00 octaves in 0.01 octave increments. Level is fixed at -80dB.
- Parametric Equalizer (PEQ) Center frequency range is 20Hz to 20kHz in 0.01Hz increments. Bandwidth is 0.05 to 5 octaves in 0.01 octave increments. Level range is -15 to +15dB in 0.5dB increments.

Filters - SmartMix

ID	Type	Frequency	Gain (dB)	Q	Bandwidth	Enable
1	HighPass	250.00				<input checked="" type="checkbox"/>
2	LowPass	8000.00				<input checked="" type="checkbox"/>
3	PEQ ▾	⊖ 408.10 ⊕	⊖ -5.65 ⊕	⊖ 4.36 ⊕	⊖ 0.3:⊕	<input checked="" type="checkbox"/>
4	None					

Graph **Phase**

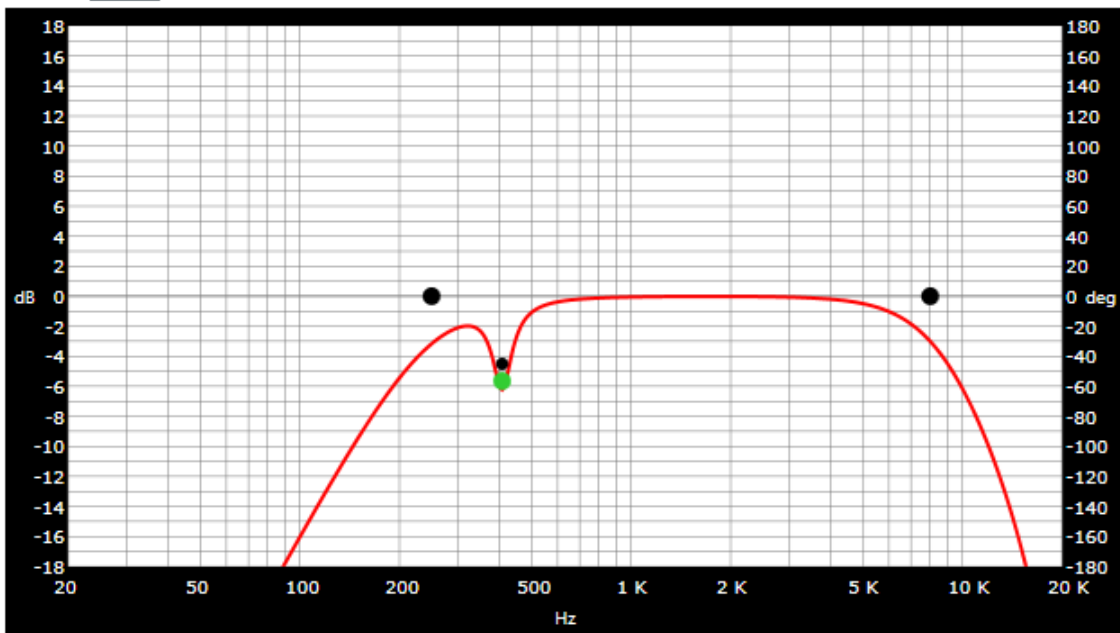

SmartMix Automatic Level Control (ALC)



ALC utilizes a level normalization algorithm to keep soft and loud local participants at a consistent level.

SmartMix AEC Reference

The BMA 360D Dante input Channel 5 delivers far-end receive audio to the built-in Acoustic Echo Canceller (AEC) so that echo can be removed from the microphone audio.

The Linked Channel drop down allows for the AEC Reference levels, filtering and Mute status to follow one of the Amplifier channels. When linked, the volume slider (b) will be disabled.

- The volume slider (b) allows for control of the AEC reference gain.
- Metered dB level of the AEC Reference signal (c) Post Gain.

