

ClearOne®

COLLABORATE® Versa™ Room CT 160



ClearOne® Contacts

Headquarters

5225 Wiley Post Way Suite 500
Salt Lake City, UT 84116

Sales

Tel: +1.801.975.7200
sales@clearone.com

Headquarters

Tel: +1.801.975-7200

Technical Support

Tel: +1.801.974.3760
collaborate.support@clearone.com

Notices

© 2023 ClearOne, Inc. All rights reserved.

Information in this document is subject to change without notice.

Document: QSG-0169-001v1.0, May 2023



Important Safety Information

1. Read, follow, and keep all instructions.
2. Do not use these devices near water.
3. Clean only with dry cloth.
4. Do not block any ventilation openings. Install in accordance with manufacturer instructions.
5. Do not install near any heat sources such as radiators, heat registers, stoves, or other apparatus (including amplifiers) that produce heat.
6. Do not defeat the safety purpose of the polarized or grounding-type plug. A polarized plug has two blades with one wider than the other. A grounding type plug has two blades and a third grounding prong. The wide blade or the third prong are provided for your safety. If the provided plug does not fit into your outlet, consult an electrician for replacement of the obsolete outlet.
7. Protect the PoE injector's power cord from being walked on or pinched particularly at plugs, convenience receptacles, and the point where they exit from the apparatus.
8. Only use attachments/accessories specified by the manufacturer.
9. When a cart is used, use caution when moving the cart/apparatus combination to avoid injury from tip-over.
10. Unplug this apparatus during lightning storms or when unused for long periods of time.
11. Refer all servicing to qualified service personnel. Servicing is required when the apparatus has been damaged in any way, such as power-supply cord or plug is damaged, liquid has been spilled or objects have fallen into the apparatus, the apparatus has been exposed to rain or moisture, does not operate normally, or has been dropped.
12. Disconnect the apparatus from the AC mains with the mains plug. This plug shall remain readily operable.
13. Never push objects of any kind into this product through cabinet slots as they may touch dangerous voltage points or short out parts that could result in fire or electric shock.
14. This product can interfere with electrical equipment such as tape recorders, TV sets, radios, computers and microwave ovens if placed in close proximity.
15. Class 2 Wiring IS REQUIRED. Only qualified personnel should wire and install.
16. Underwriters Laboratories (UL) requires these safety notifications:

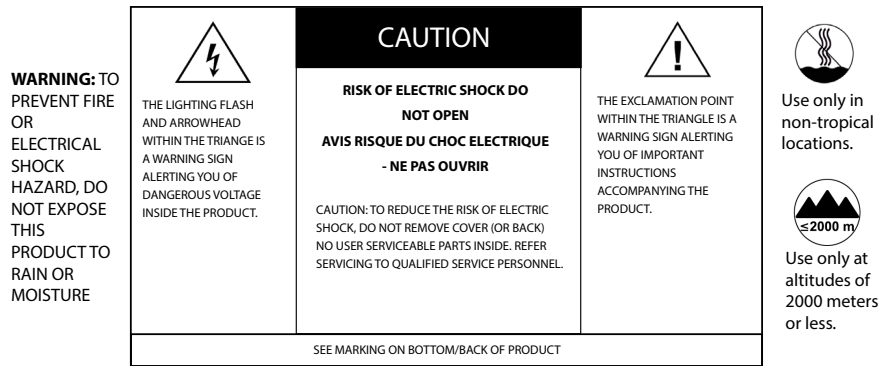

Operating Requirements

System Power and Thermal

- Power Type: PoE/PoE+
- Port Type: RJ-45
- PoE In/P-Link In: 802.3af or 802.3at PoE/PoE+
- Power Source: PoE Injector or equivalent
- PoE: IEEE 802.3at compliant devices providing 56V and 640 mA (36 W).
- P-Link In - Mode B

Power Consumption

- 100-240VAC, 50/60Hz, 3 Watts Typical
- 38W at max power 1kHz (2 x 10W)
- Thermal: 130 BTU/Hr at max power
- Operating Temperature: 14° F/-10° C to 104° F/40° C ambient temperature

System Part Number

- 930-3200-020-U - COLLABORATE Versa Room CT
- 930-3200-020-I - COLLABORATE Versa Room CT INTL

Packing List

Verify that you have received all parts associated with each of the following components:

- | | |
|------------------------|-------------------------|
| 1. BMA CT | 5. UNITE 160 4K Camera |
| 2. Versa USB | 6. Ceiling Loudspeakers |
| 3. PoE (Injector) Kit | 7. Cables |
| 4. CONVERGE® Versa Hub | |

Inspect your shipment carefully.

If the shipment shows obvious signs of damage, retain original boxes and packing material for inspection by the carrier, and contact the carrier immediately.

ClearOne is not responsible for product damage incurred during shipment.

1. BMA CT

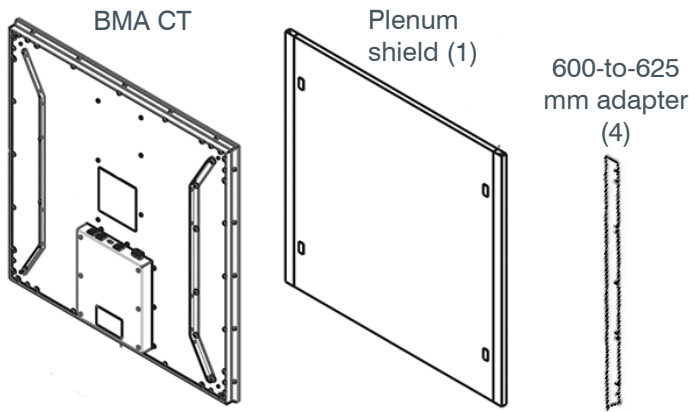

2. Versa USB



3. PoE (Injector) Kit



4. COLLABORATE Versa Hub



5. UNITE 160 4K Camera



Includes UNITE 160 Camera Quick-Start Guide

6. Ceiling Loudspeakers (2)

Includes installation instructions and ceiling tile cutout template



7. Cables

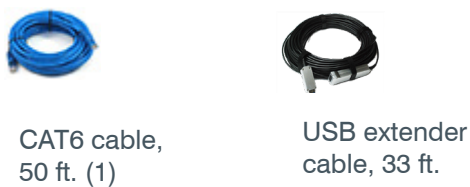

Basic Versa Room CT 160 Connections

The steps listed below and the accompanying illustration describe how to connect your Versa Lite.

1. Connect the PoE injector to the Versa USB PoE In port.
2. On the Versa USB, move the Power Select switch to the PoE In position.
3. Connect the Versa USB P-Link Out port to the BMA CT P-Link In port.
4. On the BMA CT, move the Power Select switch to the P-Link In position.
5. Connect the Versa USB Audio port to a Versa Hub USB port.
6. Connect the Versa Hub's USB In port to your PC's USB port.

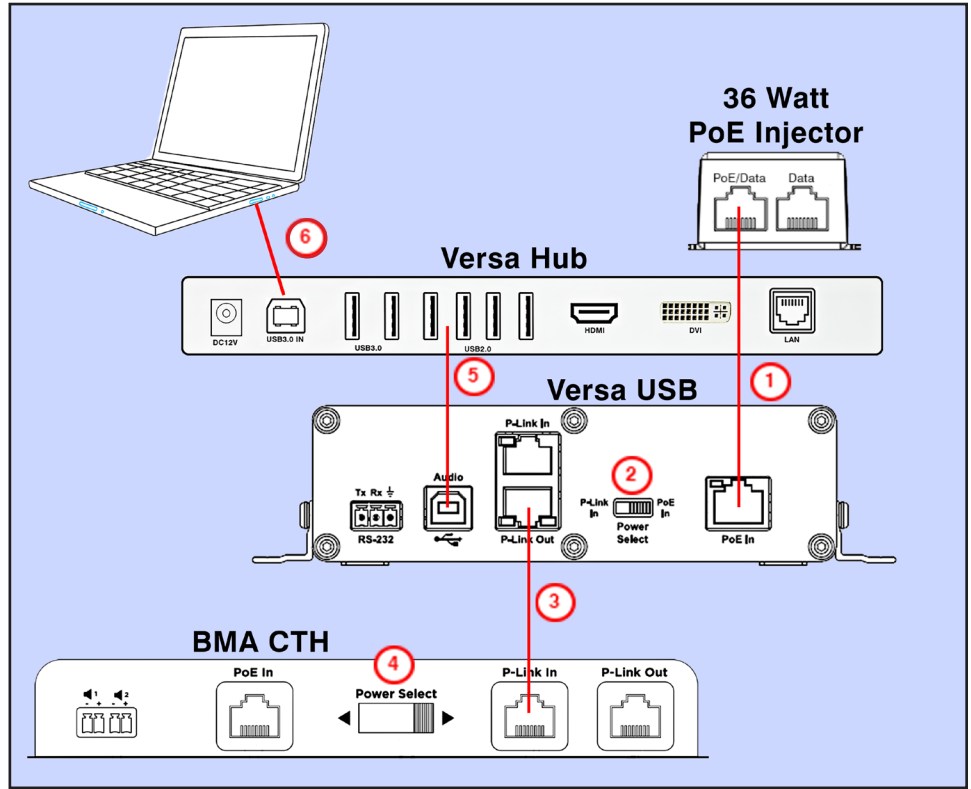

Mount the Components

BMA - CT

1. On the BMA CT back panel, do the following:
 - With speaker wire (not included), connect the two loudspeakers to the Phoenix Euroblock connectors (a)
 - Move the Power Select sliding switch (b) to the right, towards the P-Link In connector (c)

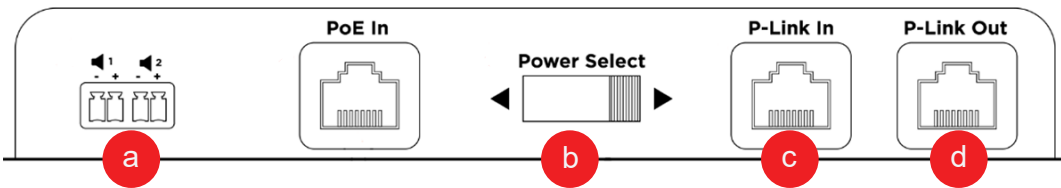

2. Complete the steps indicated in the BMA Surface Mount Kit Installation Guide

Versa USB

You can mount the Versa USB in the following ways:

- Standard equipment rack
- On a wall
- Bottom side of a table top
- Above the ceiling

Note: Mounting hardware such as screws and anchors are not included with the Versa USB.

Required Tools

- No. 1 Phillips screwdriver
- Drill bits appropriate for anchors
- T15 Torx screwdriver
- Electric drill
- Level (to level the Versa USB)
- Drywall saw (for cutting hole in wall or ceiling)

Standard Equipment Rack Mount

ClearOne offers a standard 1U rack shelf with 20 lb (9kg) weight capacity.

1. Determine location for rack shelf.
2. Align mounting holes on rack shelf mounting ears with holes on the rack (at determined location).
3. Insert the four #10-32 screws included with the ClearOne 1U rack shelf (or proper screws for your third-party mount) and tighten.

Note: Remove pre-installed mounting ears on expander to fit up to 3 Versa USB units side-by-side on a single ClearOne 1U rack shelf.

4. Torx drive screws secure the pre-installed mounting ears to the main body of the Versa USB. Remove them with a Torx T15 screwdriver. (optional)
5. Secure the Versa USB to the rack shelf. You must supply your own hardware (four #6 or M3.5 screws) for securing the Versa USB.

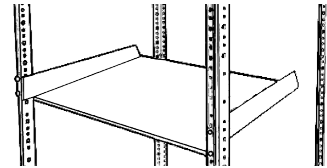

Bottom Side of a Table Top Mount

Select your hardware based on your specific installation needs.

1. Determine the location for the Versa Hub.
2. Use a pencil to mark on the table the location of four mounting holes that align with the mounting holes on the Versa USB mounting ears.
3. Determine the proper depth and diameter for the holes.
4. Drill four pilot holes for #6 or M3.5 screws.
5. Align the mounting holes on the Versa USB mounting ears with the pilot holes.
6. Use four #6 or M3.5 screws to attach the Versa Hub to the table.

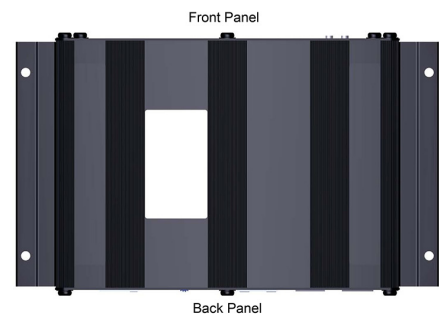

Wall Mount

Select your hardware based on your specific installation needs.

1. Determine location for the Versa USB.
2. Use a pencil to mark on the table the location of four mounting holes that align with the mounting holes on the Versa USB mounting ears. If needed, use a level.
3. With the proper size drill bits, drill four pilot holes for fasteners/anchors.
4. Install the fasteners/anchors in the wall.
5. Align the mounting holes on the Versa USB mounting ears with the pilot holes.
6. Use four #6 or M3.5 screws to attach the Versa Hub to the wall.

Note: Anchors and screws to mount the Versa USB are not provided. The installer must select them for the wall material that supports the unit. Exercise care when you drill and install anchors so wall material does not tear out and weaken the attachment.

Above the Ceiling Mount

Select hardware based on your specific installation needs.

Note: It is the installer’s responsibility to ensure that the installation and cable routing complies with local safety codes.

1. Determine location for the mount, and where to route cables.
Mark location where you want to route cables through with a pencil (on finished side of ceiling tile) if you need to cut a hole.
2. Remove affected ceiling tile and adjacent tiles required for access.
3. Install fasteners/anchors.
4. Install the Versa USB at determined location.
5. Use a drywall saw to cut a hole into finished side of ceiling tile at marked location.
6. Route the cables through the hole.

Note the following:

- Carefully run connected cables so they do not block the cooling vents or put strain on the connectors.
- Anchors and screws used to mount the Versa USB are not provided and must be selected by installer for the type of ceiling material supporting the unit. Take care while drilling and installing anchors so ceiling material does not tear out and weaken attachment.

Mount the Versa Hub, UNITE 160 4K Camera, and Ceiling Loudspeakers

Follow the instructions in the respective Quick-Start or Installation Guide (included).

Connect the Components



Warning:

Power over Ethernet (PoE) equipment used with Xceed BMA Room must meet the IEEE 802.3af or 802.3at standards.

You should use the PoE Power Injector provided with Xceed BMA Room. Other power source equipment may immediately apply power and could damage the Xceed BMA Room components.

Complete step 1 NOW if you did not when you installed the BMA CT with the surface mount kit.

1. On the BMA CT back panel, do the following:
 - With speaker wire (not included), connect the two loudspeakers to the Phoenix Euroblock connectors (a)
 - Move the Power Select sliding switch (b) to the right, towards the P-Link In connector (c)

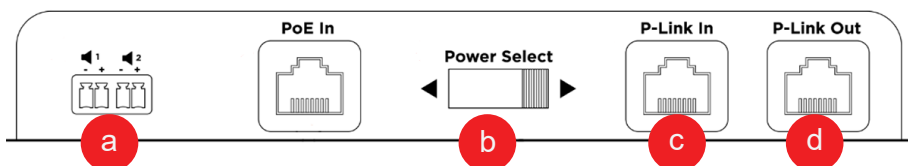

2. On the Versa USB, set the Power select switch (h) towards PoE In.

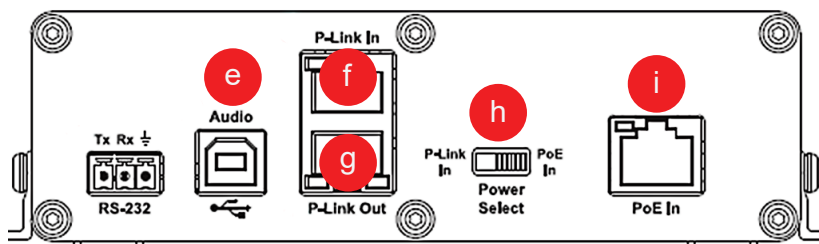

- With a 50' CAT6 cable (provided), connect the BMA CT P-Link In connector (c) to the Versa USB P-Link Out connector (g).

- Optional**

If your system includes a Bluetooth expander (available separately), complete this step.

If not, skip this step and proceed to step 5.

With a CAT6 cable (not included):

Connect the BMA CT P-Link Out connector (d) to the Bluetooth Expander.

- With one of the included 25 ft. CAT6 cables, connect the Versa USB PoE In connector (i) to the PoE injector connector (j).

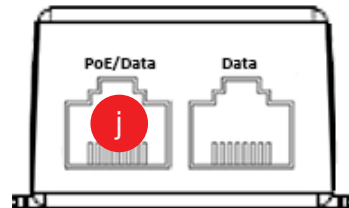

- With the provided USB cable, connect the Versa USB Audio connector (e) to the Versa Hub USB connector (m) (any one of the four).



- As needed, use the provided 33 ft. USB extender cable to connect the UNITE camera to the Versa Hub connector (l) (either of the two).

- Connect the Versa Hub 12 VDC power connector (k) to a standard power outlet.

- Caution:** Complete this connection step only after you confirm that you correctly completed the previous steps!

With the PoE Injector:

- Attach the power cord to the power supply.
- Connect the power cord to a standard power outlet.